

Approval body for construction products
and types of construction

Bautechnisches Prüfamt

An institution established by the Federal and
Laender Governments



European Technical Assessment

ETA-15/0197
of 9 December 2015

English translation prepared by DIBt - Original version in German language

General Part

Technical Assessment Body issuing the
European Technical Assessment:

Deutsches Institut für Bautechnik

Trade name of the construction product

Injection system Hilti HIT-HY 170

Product family
to which the construction product belongs

Injection system for use in masonry

Manufacturer

Hilti AG
Feldkircherstraße 100
9494 Schaan
FÜRSTENTUM LIECHTENSTEIN

Manufacturing plant

Hilti Werke

This European Technical Assessment
contains

26 pages including 3 annexes which form an integral part
of this assessment

This European Technical Assessment is
issued in accordance with Regulation (EU)
No 305/2011, on the basis of

Guideline for European technical approval of "Metal
Injection Anchors for Use in Masonry", ETAG 029,
April 2013,
used as European Assessment Document (EAD)
according to Article 66 Paragraph 3 of Regulation (EU)
No 305/2011.

This version replaces

ETA-15/0197 issued on 28 April 2015

The European Technical Assessment is issued by the Technical Assessment Body in its official language. Translations of this European Technical Assessment in other languages shall fully correspond to the original issued document and shall be identified as such.

Communication of this European Technical Assessment, including transmission by electronic means, shall be in full. However, partial reproduction may only be made with the written consent of the issuing Technical Assessment Body. Any partial reproduction shall be identified as such.

This European Technical Assessment may be withdrawn by the issuing Technical Assessment Body, in particular pursuant to information by the Commission in accordance with Article 25(3) of Regulation (EU) No 305/2011.

1 Technical description of the product

The Injection system Hilti HIT-HY 170 for masonry is a bonded anchor (injection type) consisting of a mortar foil pack with injection mortar Hilti HIT-HY 170, a perforated sieve sleeve and an anchor rod with hexagon nut and washer in the range of M8 to M12 or an internal threaded sleeve in the range of M8 to M12. The steel elements are made of zinc coated steel, stainless steel or high corrosion resistant steel.

The anchor rod is placed into a drilled hole filled with injection mortar and is anchored via the bond and/or mechanical interlock between steel element, injection mortar and masonry.

The product description is given in Annex A.

2 Specification of the intended use in accordance with the applicable European Assessment Document

The performances given in Section 3 are only valid if the anchor is used in compliance with the specifications and conditions given in Annex B.

The verifications and assessment methods on which this European Technical Assessment is based lead to the assumption of a working life of the anchor of at least 50 years. The indications given on the working life cannot be interpreted as a guarantee given by the producer, but are to be regarded only as a means for choosing the right products in relation to the expected economically reasonable working life of the works.

3 Performance of the product and references to the methods used for its assessment

3.1 Mechanical resistance and stability (BWR 1)

Essential characteristic	Performance
Characteristic resistance for steel elements	See Annex C2
Characteristic resistance for anchors in masonry units	See Annex C3 – C8
Displacements under shear and tension loads	See Annex C3 – C8
Reduction Factor for job site tests (β -Factor)	See Annex C1
Edge distances and spacing	See Annex C3 – C8
Group factor for group fastenings	See Annex C3 – C8

3.2 Safety in case of fire (BWR 2)

Essential characteristic	Performance
Reaction to fire	Class A1
Resistance to fire	No performance assessed

3.3 Hygiene, health and the environment (BWR 3)

Regarding dangerous substances there may be requirements (e.g. transposed European legislation and national laws, regulations and administrative provisions) applicable to the products falling within the scope of this European Technical Assessment. In order to meet the provisions of Regulation (EU) No 305/2011, these requirements need also to be complied with, when and where they apply.

3.4 Safety in use (BWR 4)

The essential characteristics regarding Safety in use are included under the Basic Works Requirement Mechanical resistance and stability.

4 Assessment and verification of constancy of performance (AVCP) system applied, with reference to its legal base

In accordance with guideline for European technical approval ETAG 029, April 2013 used as European Assessment Document (EAD) according to Article 66 Paragraph 3 of Regulation (EU) No 305/2011 the applicable European legal act is: [97/177/EC].

The system to be applied is: 1

5 Technical details necessary for the implementation of the AVCP system, as provided for in the applicable European Assessment Document

Technical details necessary for the implementation of the AVCP system are laid down in the control plan deposited at Deutsches Institut für Bautechnik.

Issued in Berlin on 9 December 2015 by Deutsches Institut für Bautechnik

Uwe Bender
Head of Department

beglaubigt:
Wittstock

Installed condition

Figure A1: Hollow and solid brick with threaded rod, HIT-V-... and sieve sleeve HIT-SC (see Table B5) or with internally threaded sleeve HIT-IC and sieve sleeve HIT-SC (see Table B6)

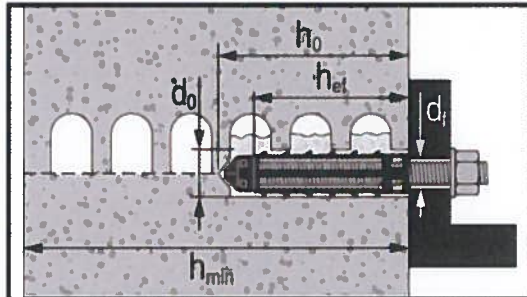

Figure A2: Solid brick with threaded rod, HIT-V-... (see Table B7)

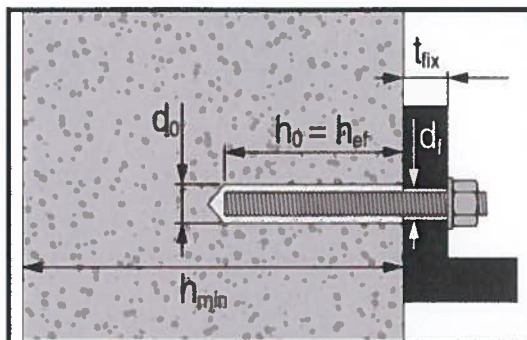
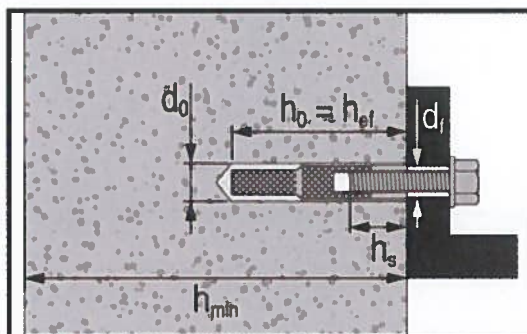

Figure A3: Solid brick with internally threaded sleeve HIT-IC (see Table B8)



<p>Hilti HIT-HY 170</p>	
<p>Product description Installed condition.</p>	<p>Annex A1</p>

Product description: Injection mortar and steel elements

**Injection mortar Hilti HIT-HY 170: hybrid system with aggregate
330 ml and 500 ml**

Marking

HILTI HIT
Production number and
production line
Expiry date mm/yyyy



Product name: "Hilti HIT-HY 170"

Static mixer Hilti HIT-RE-M



Threaded rod, HIT-V-...: M8 to M12

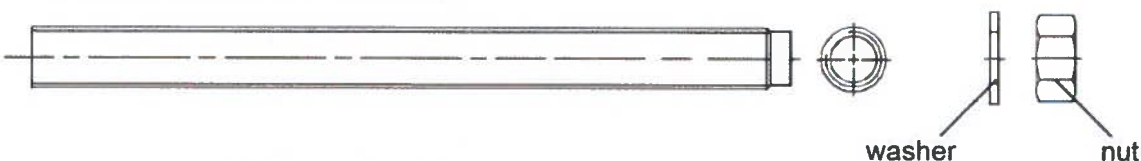

Commercial standard threaded rod with:

- Materials and mechanical properties according to Table A1.
- Inspection certificate 3.1 according to EN 10204:2004. The documents shall be stored.
- Marking of embedment depth.

Internally threaded sleeve: HIT-IC M8 to M12



Marking:
e. g. HIT-IC M8x80

Sieve sleeve: HIT-SC 16 to 22

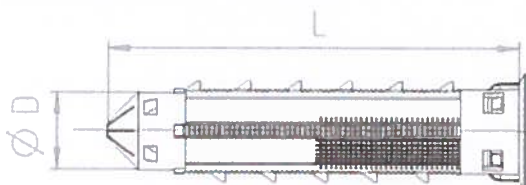

Head marking:
e. g. HIT-SC 18x85

<p>Hilti HIT-HY 170</p>	<p>Annex A2</p>
<p>Product description Injection mortar / Static mixer / Steel elements / Sieve sleeve.</p>	

Table A1: Materials

Designation	Material
Metal parts made of zinc coated steel	
Threaded rod HIT-V-5.8(F)	Strength class 5.8, $f_{uk} = 500 \text{ N/mm}^2$, $f_{yk} = 400 \text{ N/mm}^2$. Elongation at fracture ($l_0 = 5d$) > 8% ductile. Electroplated zinc coated $\geq 5 \mu\text{m}$, (F) Hot dip galvanized $\geq 45 \mu\text{m}$.
Threaded rod HIT-V-8.8(F)	Strength class 8.8, $f_{uk} = 800 \text{ N/mm}^2$, $f_{yk} = 640 \text{ N/mm}^2$. Elongation at fracture ($l_0 = 5d$) > 8% ductile. Electroplated zinc coated $\geq 5 \mu\text{m}$, (F) Hot dip galvanized $\geq 45 \mu\text{m}$.
Internally threaded sleeve HIT-IC	$f_{uk} = 490 \text{ N/mm}^2$, $f_{yk} = 390 \text{ N/mm}^2$. Elongation at fracture ($l_0 = 5d$) > 8% ductile. Electroplated zinc coated $\geq 5 \mu\text{m}$.
Washer	Electroplated zinc coated $\geq 5 \mu\text{m}$. Hot dip galvanized $\geq 45 \mu\text{m}$.
Nut	Strength class of nut adapted to strength class of threaded rod. Electroplated zinc coated $\geq 5 \mu\text{m}$, (F) Hot dip galvanized $\geq 45 \mu\text{m}$.
Metal parts made of stainless steel	
Threaded rod HIT-V-R	Strength class 70 $f_{uk} = 700 \text{ N/mm}^2$, $f_{yk} = 450 \text{ N/mm}^2$. Elongation at fracture ($l_0 = 5d$) > 8% ductile. Stainless steel 1.4401, 1.4404, 1.4578, 1.4571, 1.4439, 1.4362 EN 10088-1:2014.
Washer	Stainless steel 1.4401, 1.4404, 1.4578, 1.4571, 1.4439, 1.4362 EN 10088-1:2014.
Nut	Strength class of nut adapted to strength class of threaded rod Stainless steel 1.4401, 1.4404, 1.4578, 1.4571, 1.4439, 1.4362 EN 10088-1:2014.
Metal parts made of high corrosion resistant steel	
Threaded rod HIT-V-HCR	$f_{uk} = 800 \text{ N/mm}^2$, $f_{yk} = 640 \text{ N/mm}^2$. Elongation at fracture ($l_0 = 5d$) > 8% ductile. High corrosion resistant steel 1.4529, 1.4565 EN 10088-1:2014.
Washer	High corrosion resistant steel 1.4529, 1.4565 EN 10088-1:2014.
Nut	Strength class of nut adapted to strength class of threaded rod. High corrosion resistant steel 1.4529, 1.4565 EN 10088-1:2014.
Plastic parts	
Sieve sleeve HIT-SC	Frame: FPP 20T. Sieve: PA6.6 N500/200.

Hilti HIT-HY 170

Product description
Materials.

Annex A3

Specifications of intended use

Base materials:

- Solid brick masonry (use category b) according to Annex B3.
Note: The characteristic resistances are also valid for larger brick sizes and larger compressive strengths of the masonry unit.
- Hollow brick masonry (use category c) according to Annex B3 and B5.
- Mortar strength class of the masonry: M2,5 at minimum according to EN 998-2:2010.
- For masonry made of other solid, hollow or perforated bricks, the characteristic resistance of the anchor may be determined by job site tests according to ETAG 029, Annex B under consideration of the β -factor given in Annex C1, Table C1.

Table B1: Overview use categories

Anchorages subject to:		HIT-HY 170 with threaded rod, HIT-V-... or HIT-IC	
		in solid bricks	in hollow bricks
Hole drilling		hammer mode	rotary mode
Static and quasi static loading		Annex: C2 (steel), C3, C4	Annex: C2 (steel), C5, C6, C7, C8
Use category: dry or wet structure		Category d/d - Installation and use in structures subject to dry internal conditions. Category w/d - Installation in dry or wet substrate and use in structures subject to dry internal conditions Category w/w - Installation and use in structures subject to dry or wet environmental conditions	
Installation direction		horizontal	
Use category		b (solid masonry)	c (hollow or perforated masonry)
Temperature in the base material at installation		+5 °C to +40 °C (Table B9)	-5 °C to +40 °C (Table B10)
In-service temperature	Temperature range Ta:	-40 °C to +40 °C	(max. long term temperature +24 °C and max. short term temperature +40 °C)
	Temperature range Tb:	-40 °C to +80 °C	(max. long term temperature +50 °C and max. short term temperature +80 °C)

Hilti HIT-HY 170	Annex B1
Intended Use Specifications.	

Use conditions (Environmental conditions):

- Structures subject to dry internal conditions (zinc coated steel, stainless steel or high corrosion resistant steel).
- Structures subject to external atmospheric exposure (including industrial and marine environment) and to permanently damp internal conditions, if no particular aggressive conditions exist (stainless steel or high corrosion resistant steel).
- Structures subject to external atmospheric exposure and to permanently damp internal conditions, if other particular aggressive conditions exist (high corrosion resistant steel).

Note: Particular aggressive conditions are e.g. permanent, alternating immersion in seawater or the splash zone of seawater, chloride atmosphere of indoor swimming pools or atmosphere with extreme chemical pollution (e.g. in desulphurization plants or road tunnels where de-icing products are used).

Design:







- Anchorages are designed under the responsibility of an engineer experienced in anchorages and masonry work.
- Verifiable calculation notes and drawings are prepared taking account of the loads to be anchored. The position of the anchor is indicated on the design drawings (e. g. position of the anchor relative to supports).
- Anchorages under static or quasi-static loading are designed in accordance with: ETAG 029, Annex C, Design method A.

Installation:

- Anchor installation carried out by appropriately qualified personnel and under the supervision of the person responsible for technical matters of the site.

Hilti HIT-HY 170	Annex B2
Intended Use Specifications.	

Table B2: Overview brick types and properties











Brick type	Picture	Brick size [mm]	Compressive strength [N/mm ²]	Bulk density [kg/dm ³]	Annex
Solid clay brick EN 771-1		≥ 240x115x113	12	2,0	C3
Solid calcium silicate brick EN 771-2		≥ 240x115x113	12 / 28	2,0	C4
Hollow clay brick EN 771-1		300x240x238	12 / 20	1,4	C5
Hollow calcium silicate brick EN 771-2		248x240x238	12 / 20	1,4	C6
Hollow lightweight concrete brick EN 771-3		495x240x238	2 / 6	0,8	C7
Hollow normal weight concrete brick EN 771-3		500x200x200	4 / 10	1,0	C8

Hilti HIT-HY 170

Intended Use
Brick types and properties.

Annex B3

**Table B3: Overview fastening elements (including sizes) and corresponding brick types.
Embedment depth $h_{ef} = 80$ mm**

Brick type	Picture	HIT-V ¹⁾ 	HIT-IC 	HIT-V ¹⁾ + HIT-SC 	HIT-IC + HIT-SC 	Annex
Solid clay brick EN 771-1		M8 to M12	M8 to M12	M8 to M12	M8 to M12	C3
Solid calcium silicate brick EN 771-2		M8 to M12	M8 to M12	M8 to M12	M8 to M12	C4
Hollow clay brick EN 771-1		-	-	M8 to M12	M8 to M12	C5
Hollow calcium silicate brick EN 771-2		-	-	M8 to M12	M8 to M12	C6
Hollow lightweight concrete brick EN 771-3		-	-	M8 to M12	M8 to M12	C7
Hollow normal weight concrete brick EN 771-3		-	-	M8 to M12	M8 to M12	C8







¹⁾ Commercial standard threaded rods can also be used.

Hilti HIT-HY 170

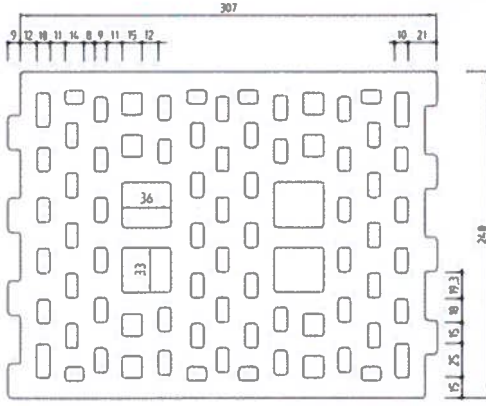
Intended Use
Fastening elements and corresponding brick types.

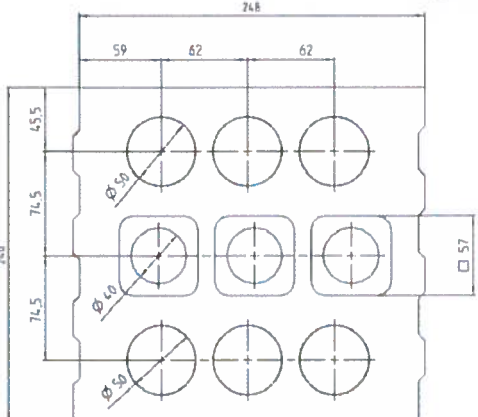
Annex B4

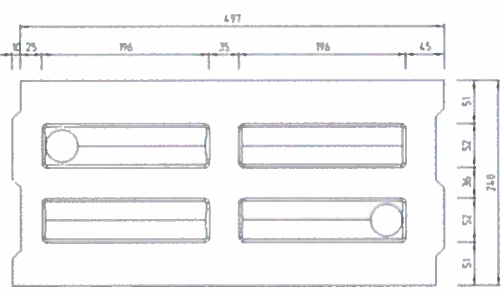
Table B4: Details of hollow bricks

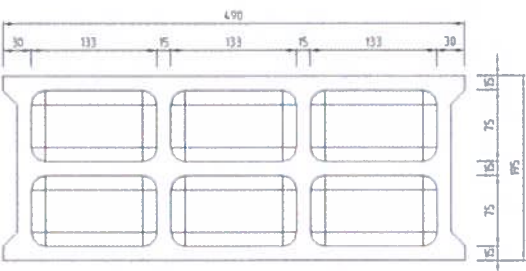
<p>Hollow clay brick EN 771-1</p> <p>Rapis Ziegel Hz 12-1,4-10DF</p>  	<p>Hollow calcium silicate brick EN 771-2</p> <p>KS Südbayern KSL-R(P) 12-1,4-8DF</p>  
<p>Hollow lightweight concrete brick EN 771-3</p> <p>Knobel Betonwerk Hbl 6-0,8-500x240x238</p>  	<p>Hollow normal weight concrete brick EN 771-3</p> <p>Parpaing creux B40</p>  

Hilti HIT-HY 170

Intended Use
Details of hollow bricks.

Annex B5

Table B5: Installation parameters of threaded rod, HIT-V-... with sieve sleeve HIT-SC in hollow brick and solid brick (Figure A1)





Threaded rod, HIT-V-...		M8	M10	M12
with HIT-SC		16x85	16x85	18x85
Nominal diameter of drill bit	d_0 [mm]	16	16	18
Drill hole depth	h_0 [mm]	95	95	95
Effective embedment depth	h_{ef} [mm]	80	80	80
Maximum diameter of clearance hole in the fixture	d_f [mm]	9	12	14
Minimum wall thickness	h_{min} [mm]	115	115	115
Brush HIT-RB	- [-]	16	16	18
Maximum torque moment for all brick types except "parpaing creux"	T_{max} [Nm]	3	4	6
Maximum torque moment for "parpaing creux"	T_{max} [Nm]	2	2	3
Number of strokes HDM	- [-]	6	6	8
Number of strokes HDE-500	- [-]	5	5	6

Table B6: Installation parameters of internally threaded sleeve HIT-IC with HIT-SC in hollow brick and solid brick (Figure A1)

HIT-IC		M8x80	M10x80	M12x80
with HIT-SC		16x85	18x85	22x85
Nominal diameter of drill bit	d_0 [mm]	16	18	22
Drill hole depth	h_0 [mm]	95	95	95
Effective embedment depth	h_{ef} [mm]	80	80	80
Thread engagement length	h_s [mm]	8...75	10...75	12...75
Maximum diameter of clearance hole in the fixture	d_f [mm]	9	12	14
Minimum wall thickness	h_{min} [mm]	115	115	115
Brush HIT-RB	- [-]	16	18	22
Maximum torque moment	T_{max} [Nm]	3	4	6
Number of strokes HDM	- [-]	6	8	10
Number of strokes HDE-500	- [-]	5	6	8

Hilti HIT-HY 170

Intended Use
Installation parameters.

Annex B6

Table B7: Installation parameters of threaded rod, HIT-V-... in solid brick (Figure A2)



Threaded rod, HIT-V-...		M8	M10	M12
Nominal diameter of drill bit	d_0 [mm]	10	12	14
Drill hole depth = Effective embedment depth	$h_0 =$ h_{ef} [mm]	80	80	80
Maximum diameter of clearance hole in the fixture	d_f [mm]	9	12	14
Minimum wall thickness	h_{min} [mm]	115	115	115
Brush HIT-RB	- [-]	10	12	14
Maximum torque moment	T_{max} [Nm]	5	8	10

Table B8: Installation parameters of internally threaded sleeve HIT-IC in solid brick (Figure A3)

HIT-IC		M8x80	M10x80	M12x80
Nominal diameter of drill bit	d_0 [mm]	14	16	18
Drill hole depth = Effective embedment depth	$h_0 =$ h_{ef} [mm]	80	80	80
Thread engagement length	h_e [mm]	8...75	10...75	12...75
Maximum diameter of clearance hole in the fixture	d_f [mm]	9	12	14
Minimum wall thickness	h_{min} [mm]	115	115	115
Brush HIT-RB	- [-]	14	16	18
Maximum torque moment	T_{max} [Nm]	5	8	10

Hilti HIT-HY 170

Intended Use
Installation parameters.

Annex B7

Table B9: Maximum working time and minimum curing time for solid bricks¹⁾

Temperature in the base material T	Maximum working time t_{work}	Minimum curing time t_{cure}
5 °C to 10 °C	8 min	2,5 h
> 10 °C to 20 °C	5 min	1,5 h
> 20 °C to 30 °C	3 min	45 min
> 30 °C to 40 °C	2 min	30 min



¹⁾ The curing time data are valid for dry base material only.
In wet base material the curing times must be doubled.

Table B10: Maximum working time and minimum curing time for hollow bricks¹⁾

Temperature in the base material T	Maximum working time t_{work}	Minimum curing time t_{cure}
-5 °C to 0 °C	10 min	12 h
> 0 °C to 5 °C	10 min	5 h
> 5 °C to 10 °C	8 min	2,5 h
> 10 °C to 20 °C	5 min	1,5 h
> 20 °C to 30 °C	3 min	45 min
> 30 °C to 40 °C	2 min	30 min

¹⁾ The curing time data are valid for dry base material only.
In wet base material the curing times must be doubled.

Table B11: Cleaning tools

<p>Manual Cleaning (MC): Hilti hand pump for blowing out drill holes</p>	
<p>Compressed air cleaning (CAC)¹⁾: air nozzle with an orifice opening of minimum 3,5 mm in diameter for blowing out drill hole</p>	
<p>Steel brush HIT-RB: according to tables B5 to B8 depending on borehole diameter for MC and CAC</p>	

¹⁾ Compressed Air Cleaning (CAC) is also allowed.

Hilti HIT-HY 170

Intended Use

Maximum working time and minimum curing time.
Cleaning tools.

Annex B8

Installation

Hole drilling

If no significant resistance is felt over the entire depth of the hole when drilling (e.g. in unfilled butt joints), the anchor should not be set at this position.

Drilling mode

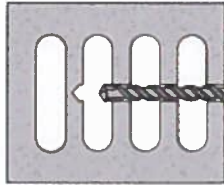

In hollow bricks (use category c): rotary mode

Drill hole to the required embedment depth with a hammer drill set in rotary mode using an appropriately sized carbide drill bit.



In solid bricks (use category b): hammer mode

Drill hole to the required embedment depth with a hammer drill set in hammer mode using an appropriately sized carbide drill bit.

Drill hole cleaning

Just before setting the anchor, the drill hole must be free of dust and debris. Inadequate hole cleaning = poor load values.

Manual Cleaning (MC) for hollow and solid bricks

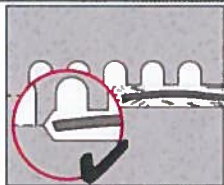

Blow out at least 2 times from the back of the drill hole with the Hilti hand pump until return air stream is free of noticeable dust.

← 2x →

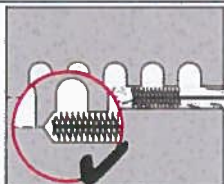

Brush 2 times with the specified steel brush (tables B5 to B8) by inserting the steel brush Hilti HIT-RB to the back of the hole in a twisting motion and removing it.

The brush must produce natural resistance as it enters the drill hole (brush $\varnothing \geq$ drill hole \varnothing) - if not the brush is too small and must be replaced with the proper brush diameter.

← 2x →

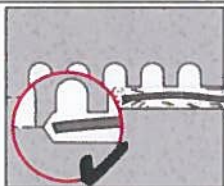

Blow out again with the Hilti hand pump at least 2 times until return air stream is free of noticeable dust.

← 2x →

Hilti HIT-HY 170

Intended Use
Installation instructions.

Annex B9

Injection preparation in masonry with holes or voids: installation with sieve sleeve HIT-SC



Sieve sleeve HIT-SC
Close lid.

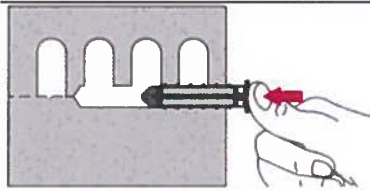

Insert sieve sleeve manually.

For all applications

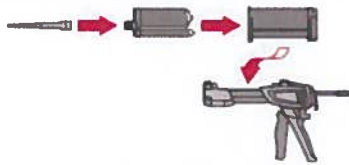

Tightly attach new Hilti mixing nozzle HIT-RE-M to foil pack manifold (snug fit). Do not modify the mixing nozzle. Observe the instruction for use of the dispenser and foil pack. Check foil pack holder for proper function. Do not use damaged foil packs / holders. Insert foil pack into foil pack holder and put holder into HIT-dispenser.



Discard initial adhesive. The foil pack opens automatically as dispensing is initiated. Depending on the size of the foil pack an initial amount of adhesive has to be discarded. Discarded quantities are:

2 strokes for 330 ml foil pack,
3 strokes for 500 ml foil pack.

Inject adhesive without forming air voids

Installation with sieve sleeve HIT-SC

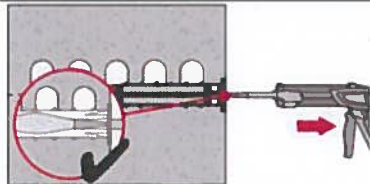

Sieve sleeve HIT-SC
Insert mixer approximately 1 cm through the lid. Inject required amount of adhesive (see tables B5 and B6). Adhesive must emerge through the lid.

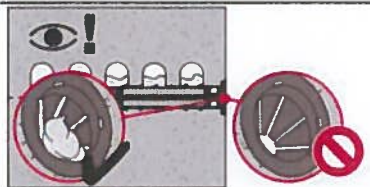

Control amount of injected mortar. Adhesive has to protrude into the lid.

After injection is completed, depressurize the dispenser by pressing the release trigger. This will prevent further adhesive discharge from the mixer.

Hilti HIT-HY 170

Intended Use
Installation instructions.

Annex B10

Solid bricks: installation without sleeve sleeve

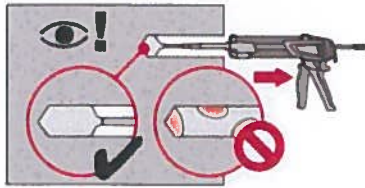

Inject the adhesive starting at the back of the hole, slowly withdrawing the mixer with each trigger pull.

Fill holes approximately 2/3 full to ensure that the annular gap between the anchor and the base material is completely filled with adhesive along the embedment length.

After injection is completed, depressurize the dispenser by pressing the release trigger. This will prevent further adhesive discharge from the mixer.

Setting the element:

Before use verify that the element is dry and free of oil and other contaminants.

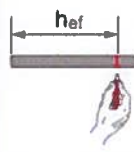
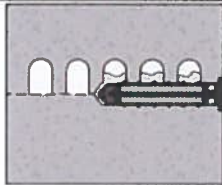

**HIT-V-... or HIT-IC in hollow and solid bricks:
Pre-setting (Figure A1 to Figure A3)**

Mark and set element to the required embedment depth until working time t_{work} has elapsed. The working time t_{work} is given in Table B9 and Table B10.

Loading the anchor

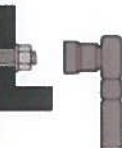
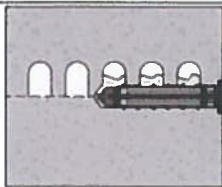

After required curing time t_{cure} (see Table B9 and Table B10) the anchor can be loaded.















The applied installation torque shall not exceed the values T_{max} given in Table B5 to Table B8.

Hilti HIT-HY 170

Intended Use
Installation instructions.

Annex B11

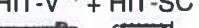
Table C1: β -factor for job-site testing under tension loading

Use categories		w/w and w/d		d/d	
Temperature range		Ta ¹⁾	Tb ¹⁾	Ta ¹⁾	Tb ¹⁾
Base material	Elements				
Solid clay brick EN 771-2	HIT-V ²⁾ or HIT-IC 	0,97	0,83	0,97	0,83
	HIT-V ²⁾ + HIT-SC 				
	HIT-IC + HIT-SC 				
Solid calcium silicate brick EN 771-2	HIT-V ²⁾ or HIT-IC 	0,96	0,84	0,97	0,84
	HIT-V ²⁾ + HIT-SC 	0,69	0,62	0,91	0,82
	HIT-IC + HIT-SC 				
Hollow clay brick EN 771-1	HIT-V ²⁾ + HIT-SC 	0,97	0,83	0,97	0,83
	HIT-IC + HIT-SC 				
Hollow calcium silicate brick EN 771-2	HIT-V ²⁾ + HIT-SC 	0,69	0,62	0,91	0,82
	HIT-IC + HIT-SC 				
Hollow light weight concrete brick EN 771-3	HIT-V ²⁾ + HIT-SC 	0,89	0,81	0,97	0,86
	HIT-IC + HIT-SC 				
Hollow normal weight concrete brick EN 771-3	HIT-V ²⁾ + HIT-SC 	0,97	0,80	0,97	0,80
	HIT-IC + HIT-SC 				

¹⁾ Temperature range Ta / Tb see Annex B1.

²⁾ Commercial standard threaded rods can also be used.

Hilti HIT-HY 170

Performances

β -factors for job-site testing under tension load.

Annex C1

Table C2: Characteristic values of steel resistance for threaded rod, HIT-V... under tension and shear loads in masonry

HIT-HY 170 with threaded rod, HIT-V...	M8	M10	M12
Steel failure tension loads			
Characteristic steel resistance $N_{Rk,s}$ [kN]	$A_s \cdot f_{uk}$		
Steel failure shear loads without lever arm			
Characteristic steel resistance $V_{Rk,s}$ [kN]	$0,5 \cdot A_s \cdot f_{uk}$		
Steel failure shear loads with lever arm			
Characteristic bending moment $M_{Rk,s}$ [kN]	$1,2 \cdot W_{el} \cdot f_{uk}$		

Table C3: Characteristic values of steel resistance for internally threaded sleeve HIT-IC under tension and shear loads in masonry

HIT-HY 170 with HIT-IC	M8	M10	M12
Steel failure tension loads			
Characteristic steel resistance $N_{Rk,s}$ [kN]	5,9	7,3	13,8
Partial safety factor $\gamma_{Ms,N}$ [-]	1,50		
Steel failure shear loads without lever arm			
Characteristic steel resistance $V_{Rk,s}$ [kN]	$0,5 \cdot A_s \cdot f_{uk}$		
Steel failure shear loads with lever arm			
Characteristic bending moment $M_{Rk,s}$ [Nm]	$1,2 \cdot W_{el} \cdot f_{uk}$		

Hilti HIT-HY 170

Performances

Characteristic resistances under tension and shear load – steel failure.

Annex C2

Brick type: Solid clay brick Mz, 2DF

Table C4: Description of brick

Brick type		[-]	Solid Mz, 2DF	
Bulk density	ρ	[kg/dm ³]	≥ 2,0	
Compressive strength	f_b	[N/mm ²]	≥ 12	
Code		[-]	EN 771 - 1	
Producer		[-]	-	
Brick dimensions		[mm]	≥ 240 x 115 x 113	
Minimum wall thickness	h_{min}	[mm]	≥ 115	





Table C5: Installation parameter for all anchor combinations (see Table B3)

Anchor type			see Table B3
Edge distance	$c_{min} = c_{cr}$	[mm]	115
Spacing	$s_{min \parallel} = s_{cr \parallel}$	[mm]	240
	$s_{min \perp} = s_{cr \perp}$	[mm]	115

Table C6: Group factor for group fastenings

Group factor	$\alpha_{0,N \parallel} \alpha_{0,V \parallel} \alpha_{0,N \perp} \alpha_{0,V \perp}$	[-]	2 at c_{cr} and s_{cr}
--------------	---	-----	----------------------------

Table C7: Characteristic tension resistance at edge distance $c \geq c_{cr}$

Use category				w/w = w/d		d/d	
Service temperature range				(Ta)	(Tb)	(Ta)	(Tb)
Anchor type and size	h_{ef} [mm]	f_b [N/mm ²]	N_{Rk} [kN]				
HIT-V ¹⁾  M8, M10, M12	80	12	3,0	2,5	3,0	2,5	
HIT-IC  M8	80	12	3,0	2,5	3,0	2,5	
			M10, M12	4,0	3,5	4,0	3,5
HIT-V ¹⁾ + HIT-SC  M8, M10, M12	80	12	4,0	3,5	4,0	3,5	
HIT-IC + HIT-SC  M8, M10, M12	80	12	4,0	3,5	4,0	3,5	

¹⁾ Commercial standard threaded rods can also be used.

Table C8: Characteristic shear resistance at edge distance $c \geq c_{cr}$

Use category				w/w = w/d		d/d	
Service temperature range				(Ta)	(Tb)	(Ta)	(Tb)
Anchor type and size	h_{ef} [mm]	f_b [N/mm ²]	V_{Rk} [kN]				
All anchors	M8, M10, M12	80	12	3,5			

Table C9: Displacements

h_{ef} [mm]	N [kN]	δ_{N0} [mm]	$\delta_{N\infty}$ [mm]	V [kN]	δ_{V0} [mm]	$\delta_{V\infty}$ [mm]
80	0,9	0,2	0,4	1,0	1,0	1,5

Hilti HIT-HY 170

Performances solid clay brick Mz, 2DF

Installation parameters and group factor.

Characteristic values of resistance under tension and shear loads. Displacements.

Annex C3

Brick type: Solid calcium silicate brick KS, 2DF

Table C10: Description of brick

Brick type		[-]	Solid KS, 2DF	
Bulk density	ρ	[kg/dm ³]	≥ 2,0	
Compressive strength	f_b	[N/mm ²]	≥ 12 or ≥ 28	
Code		[-]	EN 771 - 2	
Producer		[-]	-	
Brick dimensions		[mm]	≥ 240 x 115 x 113	
Minimum wall thickness	h_{min}	[mm]	≥ 115	





Table C11: Installation parameter for all anchor combinations (see Table B3)

Anchor type		see Table B3
Edge distance	$c_{min} = c_{cr}$ [mm]	115
Spacing	$s_{min \parallel} = s_{cr \parallel}$ [mm]	240
	$s_{min \perp} = s_{cr \perp}$ [mm]	115

Table C12: Group factor for group fastenings

Group factor	$\alpha_{q,N \parallel} \alpha_{q,V \parallel} \alpha_{q,N \perp} \alpha_{q,V \perp}$ [-]	2 at c_{cr} and s_{cr}
--------------	---	----------------------------

Table C13: Characteristic tension resistance at edge distance $c \geq c_{cr}$

Use category			w/w = w/d		d/d	
Service temperature range			(Ta)	(Tb)	(Ta)	(Tb)
Anchor type and size	h_{ef} [mm]	f_b [N/mm ²]	N_{Rk} [kN]			
HIT-V ¹⁾  M8, M10, M12	80	12	5,5	5,0	6,0	5,0
HIT-IC 		28	8,5	7,5	8,5	7,5
HIT-V ¹⁾ + HIT-SC  M8, M10, M12	80	12	4,0	3,5	5,5	5,0
HIT-IC + HIT-SC 		28	6,0	5,5	8,0	7,5

¹⁾ Commercial standard threaded rods can also be used.

Table C14: Characteristic shear resistance at edge distance $c \geq c_{cr}$

Use category			w/w = w/d		d/d	
Service temperature range			(Ta)	(Tb)	(Ta)	(Tb)
Anchor type and size	h_{ef} [mm]	f_b [N/mm ²]	V_{Rk} [kN]			
All anchors M8, M10, M12	80	12	4,0			
		28	6,0			

Table C15: Displacements

h_{ef} [mm]	N [kN]	δ_{N0} [mm]	$\delta_{N\infty}$ [mm]	V [kN]	δ_{V0} [mm]	$\delta_{V\infty}$ [mm]
80mm	2,3	0,2	0,4	1,5	1,2	1,8

Hilti HIT-HY 170

Performances solid silica brick KS, 2DF

Installation parameters and group factor.

Characteristic values of resistance under tension and shear loads. Displacements.

Annex C4

Brick type: Hollow clay brick Hz, 10DF

Table C16: Description of brick

Brick type	[-]	Hz 12-1,4-10 DF	 <p>Drawing of the brick see Table B4</p>
Bulk density	ρ [kg/dm ³]	≥ 1,4	
Compressive strength	f_b [N/mm ²]	≥ 12 or ≥ 20	
Code	[-]	EN 771 - 1	
Producer	[-]	Rapis (D)	
Brick dimensions	[mm]	300 x 240 x 238	
Minimum wall thickness	h_{min} [mm]	≥ 240	





Table C17: Installation parameter for all anchor combinations (see Table B3)

Anchor type	see Table B3	
Edge distance	$c_{min} = c_{cr}$ [mm]	150
Spacing	$s_{min \parallel} = s_{cr \parallel}$ [mm]	300
	$s_{min \perp} = s_{cr \perp}$ [mm]	240

Table C18: Group factor for group fastenings





Group factor	$\alpha_{g,N \parallel} \alpha_{g,V \parallel} \alpha_{g,N \perp} \alpha_{g,V \perp}$ [-]	2 at c_{cr} and s_{cr}
--------------	---	----------------------------

Table C19: Characteristic tension resistance at edge distance $c \geq c_{cr}$

Use category			w/w = w/d		d/d	
Service temperature range			(Ta)	(Tb)	(Ta)	(Tb)
Anchor type and size	h_{ef} [mm]	f_b [N/mm ²]	N_{Rk} [kN]			
HIT-V ¹⁾ + HIT-SC   M8, M10, M12	80	12	3,0	2,5	3,0	2,5
HIT-IC + HIT-SC   M8, M10, M12		20	3,5	3,0	3,5	3,0

¹⁾ Commercial standard threaded rods can also be used.

Table C20: Characteristic shear resistance at edge distance $c \geq c_{cr}$

Use category			w/w = w/d		d/d	
Service temperature range			(Ta)	(Tb)	(Ta)	(Tb)
Anchor type and size	h_{ef} [mm]	f_b [N/mm ²]	V_{Rk} [kN]			
HIT-V ¹⁾ + HIT-SC   M8, M10, M12	80	12	2,0			
HIT-IC + HIT-SC   M8, M10, M12		20	3,0			

¹⁾ Commercial standard threaded rods can also be used.

Table C21: Displacements

h_{ef} [mm]	N [kN]	δ_{N0} [mm]	$\delta_{N_{90}}$ [mm]	V [kN]	δ_{V0} [mm]	$\delta_{V_{90}}$ [mm]
80	0,9	0,2	0,3	0,9	1,0	1,5

Hilti HIT-HY 170

Performances hollow clay brick Hz, 10DF

Installation parameters and group factor.

Characteristic values of resistance under tension and shear loads. Displacements.

Annex C5

Brick type: Hollow calcium silicate brick KSL, 8DF

Table C22: Description of brick

Brick type	[-]	KSL-12-1,4-8 DF	 <p>Drawing of the brick see Table B4</p>
Bulk density	ρ [kg/dm ³]	≥ 1,4	
Compressive strength	f_b [N/mm ²]	≥ 12 or ≥ 20	
Code	[-]	EN 771 – 2	
Producer	[-]	KS Südbayern (D)	
Brick dimensions	[mm]	248 x 240 x 238	
Minimum wall thickness	h_{min} [mm]	≥ 240	





Table C23: Installation parameter for all anchor combinations (see Table B3)

Anchor type		see Table B3
Edge distance	$c_{min} = c_{cr}$ [mm]	125
Spacing	$s_{min \parallel} = s_{cr \parallel}$ [mm]	248
	$s_{min \perp} = s_{cr \perp}$ [mm]	240

Table C24: Group factor for group fastenings





Group factor	$\alpha_{g,N \parallel} \alpha_{g,V \parallel} \alpha_{g,N \perp} \alpha_{g,V \perp}$ [-]	2 at c_{cr} and s_{cr}
--------------	---	----------------------------

Table C25: Characteristic tension resistance at edge distance $c \geq c_{cr}$

Use category			w/w = w/d		d/d	
Service temperature range			(Ta)	(Tb)	(Ta)	(Tb)
Anchor type and size	h_{ef} [mm]	f_b [N/mm ²]	N_{Rk} [kN]			
HIT-V ¹⁾ + HIT-SC   M8, M10, M12	80	12	3,0	2,5	3,5	3,0
HIT-IC + HIT-SC  		20	4,0	3,5	5,0	4,5

¹⁾ Commercial standard threaded rods can also be used.

Table C26: Characteristic shear resistance at edge distance $c \geq c_{cr}$

Use category			w/w = w/d		d/d	
Service temperature range			(Ta)	(Tb)	(Ta)	(Tb)
Anchor type and size	h_{ef} [mm]	f_b [N/mm ²]	V_{Rk} [kN]			
HIT-V ¹⁾ + HIT-SC   M8, M10, M12	80	12	8,5			
HIT-IC + HIT-SC  		20	12,0			

¹⁾ Commercial standard threaded rods can also be used.

Table C27: Displacements

h_{ef} [mm]	N [kN]	δ_{N0} [mm]	$\delta_{N\infty}$ [mm]	V [kN]	δ_{V0} [mm]	$\delta_{V\infty}$ [mm]
80	1,8	0,2	0,3	3,4	2,5	3,8

Hilti HIT-HY 170

Performances hollow silica brick KSL, 8DF

Installation parameters and group factor.

Characteristic values of resistance under tension and shear loads. Displacements.

Annex C6

Brick type: Hollow lightweight concrete brick Hbl, 16DF

Table C28: Description of brick

Brick type	[-]	Hbl-4-0,7	 <p>Drawing of the brick see Table B4</p>
Bulk density	ρ [kg/dm ³]	≥ 0,8	
Compressive strength	f_b [N/mm ²]	≥ 2 or ≥ 6	
Code	[-]	EN 771-3	
Producer	[-]	Knobel (D)	
Brick dimensions	[mm]	495 x 240 x 238	
Minimum wall thickness	h_{min} [mm]	≥ 240	





Table C29: Installation parameter for all anchor combinations (see Table B3)

Anchor type		see Table B3
Edge distance	$c_{min} = c_{cr}$ [mm]	250
Spacing	$s_{min \parallel} = s_{cr \parallel}$ [mm]	240
	$s_{min \perp} = s_{cr \perp}$ [mm]	240

Table C30: Group factor for group fastenings





Group factor	$\alpha_{g,N \parallel} \alpha_{g,V \parallel} \alpha_{g,N \perp} \alpha_{g,V \perp}$ [-]	2 at c_{cr} and s_{cr}
--------------	---	----------------------------

Table C31: Characteristic tension resistance at edge distance $c \geq c_{cr}$

Use category			w/w = w/d		d/d	
Service temperature range			(Ta)	(Tb)	(Ta)	(Tb)
Anchor type and size	h_{ef} [mm]	f_b [N/mm ²]	N_{Rk} [kN]			
HIT-V ¹⁾ + HIT-SC   M8, M10, M12	80	2	1,2	0,9	1,5	1,2
HIT-IC + HIT-SC  		6	2,0	1,5	2,5	2,0

¹⁾ Commercial standard threaded rods can also be used.

Table C32: Characteristic shear resistance at edge distance $c \geq c_{cr}$

Use category			w/w = w/d		d/d	
Service temperature range			(Ta)	(Tb)	(Ta)	(Tb)
Anchor type and size	h_{ef} [mm]	f_b [N/mm ²]	V_{Rk} [kN]			
HIT-V ¹⁾ + HIT-SC   M8, M10, M12	80	2	2,5			
HIT-IC + HIT-SC  		6	4,0			

¹⁾ Commercial standard threaded rods can also be used.

Table C33: Displacements

h_{ef} [mm]	N [kN]	δ_{N0} [mm]	$\delta_{N\infty}$ [mm]	V [kN]	δ_{V0} [mm]	$\delta_{V\infty}$ [mm]
80	2,4	0,2	0,4	3,4	1,3	1,9

Hilti HIT-HY 170

Performances hollow lightweight concrete brick Hbl 16DF
Installation parameters and group factor.
Characteristic values of resistance under tension and shear loads. Displacements.

Annex C7

Brick type: Hollow normal weight concrete brick - parpaing creux

Table C34: Description of brick

Brick type				B40	 <p>Drawing of the brick see Table B4</p>
Bulk density	ρ	[kg/dm ³]		≥ 1,0	
Compressive strength	f_b	[N/mm ²]		≥ 4 or ≥ 10	
Code				EN 771-3	
Producer				Fabemi (F)	
Brick dimensions		[mm]		500 x 200 x 200	
Minimum wall thickness	h_{min}	[mm]		≥ 200	





Table C35: Installation parameter for all anchor combinations (see Table B3)

Anchor type		see Table B3
Edge distance	$c_{min} = c_{cr}$ [mm]	200
Spacing	$s_{min \parallel} = s_{cr \parallel}$ [mm]	200
	$s_{min \perp} = s_{cr \perp}$ [mm]	200

Table C36: Group factor for group fastenings





Group factor	$\alpha_{g,N \parallel} \alpha_{g,V \parallel} \alpha_{g,N \perp} \alpha_{g,V \perp}$ [-]	2 at c_{cr} and s_{cr}
--------------	---	----------------------------

Table C37: Characteristic tension resistance at edge distance $c \geq c_{cr}$

Use category			w/w = w/d		d/d	
Service temperature range			(Ta)	(Tb)	(Ta)	(Tb)
Anchor type and size	h_{ef} [mm]	f_b [N/mm ²]	N_{Rk} [kN]			
HIT-V ¹⁾ + HIT-SC   M8, M10, M12	80	4	0,9	0,9	0,9	0,9
HIT-IC + HIT-SC  		10	1,2	1,2	1,5	1,5

¹⁾ Commercial standard threaded rods can also be used.

Table C38: Characteristic shear resistance at edge distance $c \geq c_{cr}$

Use category			w/w = w/d		d/d	
Service temperature range			(Ta)	(Tb)	(Ta)	(Tb)
Anchor type and size	h_{ef} [mm]	f_b [N/mm ²]	V_{Rk} [kN]			
HIT-V ¹⁾ + HIT-SC   M8, M10, M12	80	4	2,5			
HIT-IC + HIT-SC  		10	4,0			

¹⁾ Commercial standard threaded rods can also be used.

Table C39: Displacements

h_{ef} [mm]	N [kN]	δ_{N0} [mm]	δ_{N10} [mm]	V [kN]	δ_{V0} [mm]	δ_{V10} [mm]
80	1,0	0,6	1,2	2,3	0,6	0,9

Hilti HIT-HY 170

Performances hollow normal weight concrete brick - parpaing creux
Installation parameters and group factor.
Characteristic values of resistance under tension and shear loads. Displacements.

Annex C8