

# HILTI

**AG 125-A36**

**AG 150-A36**

English





## 1 Information about the documentation



### 1.1 About this documentation

- Read this documentation before initial operation or use. This is a prerequisite for safe, trouble-free handling and use of the product.
- Observe the safety instructions and warnings in this documentation and on the product.
- Always keep the operating instructions with the product and make sure that the operating instructions are with the product when it is given to other persons.

### 1.2 Explanation of symbols used



#### 1.2.1 Warnings

Warnings alert persons to hazards that may occur when handling or using the product. The following signal words are used in combination with a symbol:

	<b>DANGER!</b> Draws attention to an imminent hazard that will lead to serious personal injury or fatality.
	<b>WARNING!</b> Draws attention to a potential hazard that could lead to serious personal injury or fatality.
	<b>CAUTION!</b> Draws attention to a potentially dangerous situation that could lead to minor personal injury or material damage.



#### 1.2.2 Symbols in the documentation

The following symbols are used in this document:

	Read the operating instructions before use
	Instructions for use and other useful information

#### 1.2.3 Symbols in the illustrations



The following symbols are used in illustrations:

	These numbers refer to the corresponding illustrations found at the beginning of these operating instructions.
3	The numbering reflects the sequence of operations shown in the illustrations and may deviate from the steps described in the text.
	Item reference numbers are used in the <b>overview illustration</b> and refer to the numbers used in the key in the <b>product overview</b> section.
	This symbol is intended to draw special attention to certain points when handling the product.

### 1.3 Product-dependent symbols

#### 1.3.1 Symbols on the product

The following symbols are used on the product:

	Wear eye protection.
n	Rated speed
/min	Revolutions per minute
RPM	Revolutions per minute
	Diameter

## 1.4 Product information

Hilti products are designed for professional use and may be operated, serviced and maintained only by trained, authorized personnel. This personnel must be informed of any particular hazards that may be encountered. The product and its ancillary equipment may present hazards when used incorrectly by untrained personnel or when used not as directed.

The type designation and serial number are printed on the type identification plate.

- ▶ Write down the serial number in the table below. You will be required to state the product details when contacting Hilti Service or your local Hilti organization to inquire about the product.

### Product information

Angle grinder	AG 125-A36   AG 150-A36
Generation	02
Serial no.	

## 2 Safety

### 2.1 General power tool safety warnings

#### WARNING

**Read all safety warnings and all instructions.** Failure to follow the warnings and instructions may result in electric shock, fire and/or serious injury.

**Save all warnings and instructions for future reference.**

#### Work area safety

- ▶ **Keep work area clean and well lit.** Cluttered or dark areas invite accidents.
- ▶ **Do not operate power tools in explosive atmospheres, such as in the presence of flammable liquids, gases or dust.** Power tools create sparks which may ignite the dust or fumes.
- ▶ **Keep children and bystanders away while operating a power tool.** Distractions can cause you to lose control.

#### Electrical safety

- ▶ **Power tool plugs must match the outlet. Never modify the plug in any way. Do not use any adapter plugs with earthed (grounded) power tools.** Unmodified plugs and matching outlets will reduce risk of electric shock.
- ▶ **Avoid body contact with earthed or grounded surfaces, such as pipes, radiators, ranges and refrigerators.** There is an increased risk of electric shock if your body is earthed or grounded.
- ▶ **Do not expose power tools to rain or wet conditions.** Water entering a power tool will increase the risk of electric shock.
- ▶ **Do not abuse the cord. Never use the cord for carrying, pulling or unplugging the power tool. Keep cord away from heat, oil, sharp edges or moving parts.** Damaged or entangled cords increase the risk of electric shock.
- ▶ **When operating a power tool outdoors, use an extension cord suitable for outdoor use.** Use of a cord suitable for outdoor use reduces the risk of electric shock.
- ▶ **If operating a power tool in a damp location is unavoidable, use a residual current device (RCD) protected supply.** Use of an RCD reduces the risk of electric shock.

#### Personal safety

- ▶ **Stay alert, watch what you are doing and use common sense when operating a power tool. Do not use a power tool while you are tired or under the influence of drugs, alcohol or medication.** A moment of inattention while operating power tools may result in serious personal injury.
- ▶ **Use personal protective equipment. Always wear eye protection.** Protective equipment such as dust mask, non-skid safety shoes, hard hat, or hearing protection used for appropriate conditions will reduce personal injuries.
- ▶ **Prevent unintentional starting. Ensure the switch is in the off-position before connecting to battery pack, picking up or carrying the tool.** Carrying power tools with your finger on the switch or energising power tools that have the switch on invites accidents.
- ▶ **Remove any adjusting key or wrench before turning the power tool on.** A wrench or a key left attached to a rotating part of the power tool may result in personal injury.
- ▶ **Do not overreach. Keep proper footing and balance at all times.** This enables better control of the power tool in unexpected situations.

- ▶ **Dress properly. Do not wear loose clothing or jewellery. Keep your hair, clothing and gloves away from moving parts.** Loose clothes, jewellery or long hair can be caught in moving parts.
- ▶ **If devices are provided for the connection of dust extraction and collection facilities, ensure these are connected and properly used.** Use of dust collection can reduce dust-related hazards.

#### Power tool use and care

- ▶ Do not force the power tool. Use the correct power tool for your application. The correct power tool will do the job better and safer at the rate for which it was designed.
- ▶ **Do not use the power tool if the switch does not turn it on and off.** Any power tool that cannot be controlled with the switch is dangerous and must be repaired.
- ▶ **Disconnect the battery pack from the power tool before making any adjustments, changing accessories, or storing power tools.** Such preventive safety measures reduce the risk of starting the power tool accidentally.
- ▶ **Store idle power tools out of the reach of children and do not allow persons unfamiliar with the power tool or these instructions to operate the power tool.** Power tools are dangerous in the hands of untrained users.
- ▶ **Maintain power tools. Check for misalignment or binding of moving parts, breakage of parts and any other condition that may affect the power tool's operation. If damaged, have the power tool repaired before use.** Many accidents are caused by poorly maintained power tools.
- ▶ **Keep cutting tools sharp and clean.** Properly maintained cutting tools with sharp cutting edges are less likely to bind and are easier to control.
- ▶ **Use the power tool, accessories and tool bits etc. in accordance with these instructions, taking into account the working conditions and the work to be performed.** Use of the power tool for operations different from those intended could result in a hazardous situation.

#### Battery tool use and care

- ▶ **Recharge only with the charger specified by the manufacturer.** A charger that is suitable for one type of battery pack may create a risk of fire when used with another battery pack.
- ▶ **Use power tools only with specifically designated battery packs.** Use of any other battery packs may create a risk of injury and fire.
- ▶ **When battery pack is not in use, keep it away from other metal objects, like paper clips, coins, keys, nails, screws or other small metal objects, that can make a connection from one terminal to another.** Shorting the battery terminals together may cause burns or a fire.
- ▶ **Under abusive conditions, liquid may be ejected from the battery; avoid contact. If contact accidentally occurs, flush with water. If liquid contacts eyes, additionally seek medical help.** Liquid ejected from the battery may cause irritation or burns.

#### Service

- ▶ **Have your power tool serviced by a qualified repair person using only identical replacement parts.** This will ensure that the safety of the power tool is maintained.

### 2.2 Safety warnings common for grinding, sanding, wire brushing, polishing or abrasive cutting-off operations:

- ▶ **This power tool is intended to function as a grinder or cut-off tool. Read all safety warnings, instructions, illustrations and specifications provided with this power tool.** Failure to follow all instructions listed below may result in electric shock, fire and/or serious injury.
- ▶ **Operations such as sanding, wire brushing or polishing are not recommended to be performed with this power tool.** Operations for which the power tool was not designed may create a hazard and cause personal injury.
- ▶ **Do not use accessories which are not specifically designed and recommended by the tool manufacturer.** Just because the accessory can be attached to your power tool, it does not assure safe operation.
- ▶ **The rated speed of the accessory must be at least equal to the maximum speed marked on the power tool.** Accessories running faster than their rated speed can break and fly apart.
- ▶ **The outside diameter and the thickness of your accessory must be within the capacity rating of your power tool.** Incorrectly sized accessories cannot be adequately guarded or controlled.
- ▶ **Threaded mounting of accessories must match the grinder spindle thread. For accessories mounted by flanges, the arbour hole of the accessory must fit the locating diameter of the flange.** Accessories that do not match the mounting hardware of the power tool will run out of balance, vibrate excessively and may cause loss of control.
- ▶ **Do not use a damaged accessory. Before each use inspect the accessory such as abrasive wheels for chips and cracks, backing pad for cracks, tear or excess wear, wire brush for loose or**

cracked wires. If power tool or accessory is dropped, inspect for damage or install an undamaged accessory. After inspecting and installing an accessory, position yourself and bystanders away from the plane of the rotating accessory and run the power tool at maximum no-load speed for one minute. Damaged accessories will normally break apart during this test time.

- ▶ **Wear personal protective equipment.** Depending on application, use face shield, safety goggles or safety glasses. As appropriate, wear dust mask, hearing protectors, gloves and workshop apron capable of stopping small abrasive or workpiece fragments. The eye protection must be capable of stopping flying debris generated by various operations. The dust mask or respirator must be capable of filtering particles generated by your operation. Prolonged exposure to high intensity noise may cause hearing loss.
- ▶ **Keep bystanders a safe distance away from work area. Anyone entering the work area must wear personal protective equipment.** Fragments of workpiece or of a broken accessory may fly away and cause injury beyond immediate area of operation.
- ▶ **Hold the power tool by insulated gripping surfaces only, when performing an operation where the cutting tool may contact hidden wiring.** Contact with a "live" wire will also make exposed metal parts of the power tool "live" and could give the operator an electric shock.
- ▶ **Position the cord clear of the spinning accessory.** If you lose control, the cord may be cut or snagged and your hand or arm may be pulled into the spinning accessory.
- ▶ **Never lay the power tool down until the accessory has come to a complete stop.** The spinning accessory may grab the surface and pull the power tool out of your control.
- ▶ **Do not run the power tool while carrying it at your side.** Accidental contact with the spinning accessory could snag your clothing, pulling the accessory into your body.
- ▶ **Regularly clean the power tool's air vents.** The motor's fan will draw the dust inside the housing and excessive accumulation of powdered metal may cause electrical hazards.
- ▶ **Do not operate the power tool near flammable materials.** Sparks could ignite these materials.
- ▶ **Do not use accessories that require liquid coolants.** Using water or other liquid coolants may result in electrocution or shock.

#### **Kickback and related warnings**

Kickback is a sudden reaction to a pinched or snagged rotating wheel, backing pad, brush or any other accessory. Pinching or snagging causes rapid stalling of the rotating accessory which in turn causes the uncontrolled power tool to be forced in the direction opposite of the accessory's rotation at the point of the binding.

For example, if an abrasive wheel is snagged or pinched by the workpiece, the edge of the wheel that is entering into the pinch point can dig into the surface of the material causing the wheel to climb out or kick out. The wheel may either jump toward or away from the operator, depending on direction of the wheel's movement at the point of pinching. Abrasive wheels may also break under these conditions.

Kickback is the result of power tool misuse and/or incorrect operating procedures or conditions and can be avoided by taking proper precautions as given below.

- ▶ **Maintain a firm grip on the power tool and position your body and arm to allow you to resist kickback forces.** Always use auxiliary handle, if provided, for maximum control over kickback or torque reaction during start-up. The operator can control torque reactions or kickback forces, if proper precautions are taken.
- ▶ **Never place your hand near the rotating accessory.** Accessory may kickback over your hand.
- ▶ **Do not position your body in the area where power tool will move if kickback occurs.** Kickback will propel the tool in direction opposite to the wheel's movement at the point of snagging.
- ▶ **Use special care when working corners, sharp edges etc. Avoid bouncing and snagging the accessory.** Corners, sharp edges or bouncing have a tendency to snag the rotating accessory and cause loss of control or kickback.
- ▶ **Do not attach a saw chain woodcarving blade or toothed saw blade.** Such blades create frequent kickback and loss of control.

#### **Safety warnings specific for grinding and abrasive cutting-off operations:**

- ▶ **Use only wheel types that are recommended for your power tool and the specific guard designed for the selected wheel.** Wheels for which the power tool was not designed cannot be adequately guarded and are unsafe.
- ▶ **The grinding surface of centre depressed wheels must be mounted below the plane of the guard lip.** An improperly mounted wheel that projects through the plane of the guard lip cannot be adequately protected.

- ▶ **The guard must be securely attached to the power tool and positioned for maximum safety, so the least amount of wheel is exposed towards the operator.** The guard helps to protect the operator from broken wheel fragments, accidental contact with wheel and sparks that could ignite clothing.
- ▶ **Wheels must be used only for recommended applications. For example: do not grind with the side of cut-off wheel.** Abrasive cut-off wheels are intended for peripheral grinding, side forces applied to these wheels may cause them to shatter.
- ▶ **Always use undamaged wheel flanges that are of correct size and shape for your selected wheel.** Proper wheel flanges support the wheel thus reducing the possibility of wheel breakage. Flanges for cut-off wheels may be different from grinding wheel flanges.
- ▶ **Do not use worn down wheels from larger power tools.** Wheel intended for larger power tool is not suitable for the higher speed of a smaller tool and may burst.

**Additional safety warnings specific for abrasive cutting-off operations:**

- ▶ **Do not "jam" the cut-off wheel or apply excessive pressure. Do not attempt to make an excessive depth of cut.** Overstressing the wheel increases the loading and susceptibility to twisting or binding of the wheel in the cut and the possibility of kickback or wheel breakage.
- ▶ **Do not position your body in line with and behind the rotating wheel.** When the wheel, at the point of operation, is moving away from your body, the possible kickback may propel the spinning wheel and the power tool directly at you.
- ▶ **When wheel is binding or when interrupting a cut for any reason, switch off the power tool and hold the power tool motionless until the wheel comes to a complete stop. Never attempt to remove the cut-off wheel from the cut while the wheel is in motion otherwise kickback may occur.** Investigate and take corrective action to eliminate the cause of wheel binding.
- ▶ **Do not restart the cutting operation in the workpiece. Let the wheel reach full speed and carefully re-enter the cut.** The wheel may bind, walk up or kickback if the power tool is restarted in the workpiece.
- ▶ **Support panels or any oversized workpiece to minimize the risk of wheel pinching and kickback.** Large workpieces tend to sag under their own weight. Supports must be placed under the workpiece near the line of cut and near the edge of the workpiece on both sides of the wheel.
- ▶ **Use extra caution when making a "pocket cut" into existing walls or other blind areas.** The protruding wheel may cut gas or water pipes, electrical wiring or objects that can cause kickback.

## 2.3 Additional safety instructions

### Personal safety

- ▶ Only use the product if it is in perfect working order.
- ▶ Never tamper with or modify the tool in any way.
- ▶ Avoid touching rotating parts – risk of injury!
- ▶ Wear protective gloves also when changing the accessory tool. Touching the accessory tool presents a risk of injury (cuts or burns).
- ▶ Before starting work, check the hazard class of the dust that will be produced when working. Use an industrial vacuum cleaner with an officially approved protection class in compliance with the locally applicable dust protection regulations. Dust from materials such as lead-based paint, certain types of wood and concrete/masonry/stone containing quartz, minerals or metal may be harmful to health.
- ▶ Make sure that the workplace is well ventilated and, where necessary, wear a respirator appropriate for the type of dust generated. Contact with or inhalation of the dust may cause allergic reactions and/or respiratory or other diseases among operators or bystanders. Certain kinds of dust are classified as carcinogenic such as oak and beech dust, especially in conjunction with additives for wood conditioning (chromate, wood preservative). Material containing asbestos may be handled only by specialists.
- ▶ Take breaks between working and do physical exercises to improve the blood circulation in your fingers. Exposure to vibration during long periods of work can lead to disorders of the blood vessels and nervous system in the fingers, hands and wrists.

### Electrical safety

- ▶ Before beginning work, check the working area for concealed electric cables or gas and water pipes. External metal parts of the power tool may give you an electric shock if you damage an electric cable accidentally.

### Using and handling power tools with care

- ▶ Do not use cutting discs for grinding.
- ▶ Tighten the accessory tool and flange securely. If the accessory tool and flange are not tightened securely, the accessory tool may work loose from the spindle due to the braking effect of the motor after switching off.
- ▶ Comply with the manufacturer's instructions for handling and storing grinding discs.

## 2.4 Careful handling and use of batteries

- ▶ Observe the special guidelines applicable to the transport, storage and use of lithium-ion batteries.
- ▶ Do not expose batteries to high temperatures, direct sunlight or fire.
- ▶ Do not take apart, squash or incinerate batteries and do not subject them to temperatures over 80 °C.
- ▶ Do not attempt to charge or continue to use damaged batteries.
- ▶ If the battery is too hot to touch, it may be defective. In this case, place the power tool in a non-flammable location, well away from flammable materials, where it can be kept under observation and left to cool down. Contact **Hilti** Service after the battery has cooled down.







### 3 Description

#### 3.1 Overview of the product

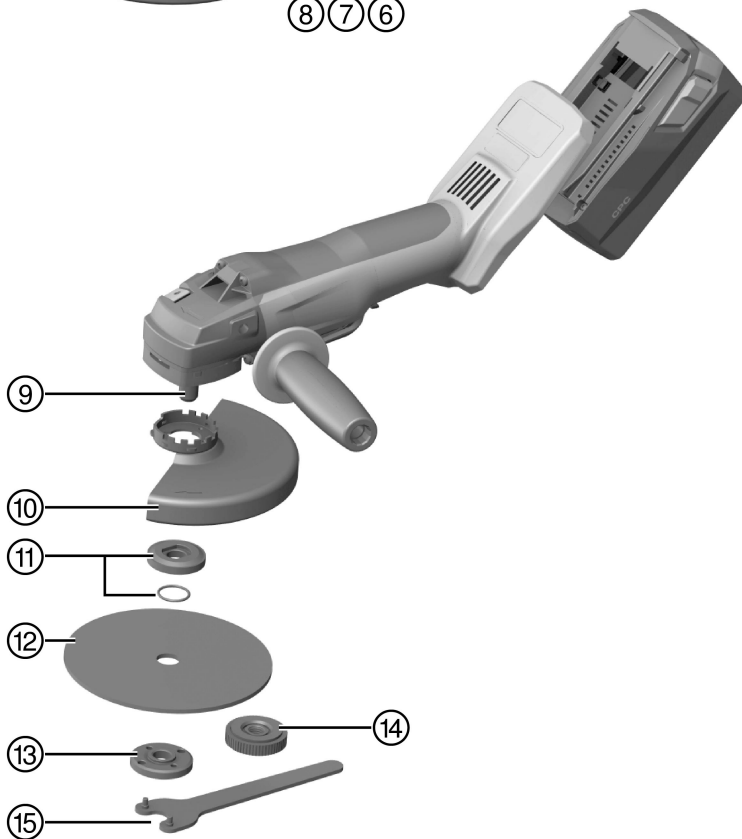
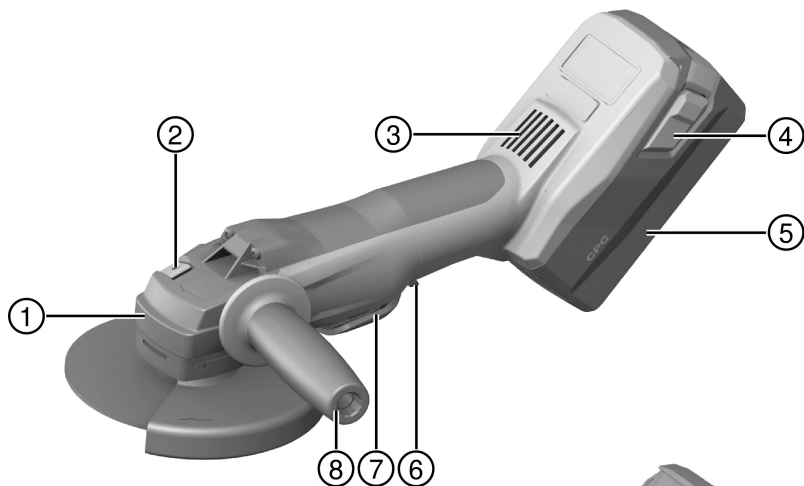

- |   |   |
|---|---|
| ① Guard release button  | ⑨ Spindle   |
| ② Spindle lockbutton  | ⑩ Standard guard                                    |
| ③ Air vents   | ⑪ Clamping flange with O-ring                       |
| ④ Release button with additional function<br>(charge status display activation) | ⑫ Abrasive cutting disc / abrasive grinding<br>disc |
| ⑤ Battery   | ⑬ Clamping nut                                      |
| ⑥ Switch-on interlock release button  | ⑭ <b>Kwik lock</b> clamping nut (optional)          |
| ⑦ On/off switch   | ⑮ Wrench  |
| ⑧ Vibration-absorbing side handle   |   |

### 3.2 Intended use

The product described is a hand-held cordless angle grinder. It is designed to be used for cutting and grinding metals and mineral materials, and for drilling tiles without use of water. It can be used only for dry grinding / cutting.

- The tool can be used for cutting, slitting and grinding mineral materials only in combination with the appropriate guard (optional accessory).
- It is recommended that a dust removal system consisting of matched components, i.e. dust removal hood and a suitable **Hilti** vacuum cleaner, are used for working on mineral materials such as concrete or stone. These protect the operator and increase the life of the tool and accessory tools used.
- ▶ Use only **Hilti** Li-ion batteries from the B 36 series with this product.
- ▶ Use only the **Hilti** battery chargers from the C4/36 series for these batteries.

### 3.3 Items supplied

Angle grinder, side handle, standard guard, front cover, clamping flange, clamping nut, wrench, operating instructions.

### 3.4 Temperature-dependent motor protection

The temperature-dependent motor protection system monitors current input and motor temperature and thus prevents the power tool overheating.

If the motor is overloaded through application of excessive working pressure, the power tool's performance drops noticeably or it may stall completely.

If the power tool stalls or slows significantly due to overloading, release the pressure applied to the tool and then allow it to run under no load for approx. 30 seconds.

### 3.5 Guard with front cover



**When grinding with straight grinding discs and cutting with cutting discs in metalworking applications, use the standard guard with front cover.**

### 3.6 Dust hood for cutting: DC-EX 125/5" C compact hood (accessory)

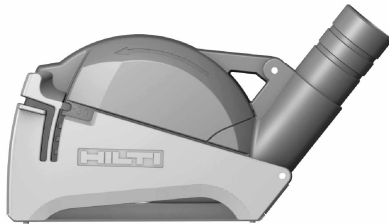

When cutting mineral materials with diamond cutting discs, use the DC-EX 125/5" C compact hood.

**CAUTION** Use of this hood for working on metal is prohibited.

### 3.7 DG-EX 125/5" dust hood for grinding (accessory)



The grinding system is suitable only for occasional use with diamond cup wheels for grinding mineral materials.

**CAUTION** Use of this hood for working on metal is prohibited.

### 3.8 Consumables

Use only synthetic-resin-bonded, fiber-reinforced discs with a maximum  $\varnothing$  of 125 mm or max.  $\varnothing$  of 150 mm, as applicable, approved for a peripheral speed of 80 m/s.

The maximum grinding disc thickness is 6.4 mm and the maximum cutting disc thickness is 2.5 mm.

**WARNING!** When cutting or slitting with abrasive cutting discs always use the standard guard with the additional front cover, or a fully enclosing dust hood.

#### Discs

	Application	Designation	Material
Abrasive cutting disc	Cutting, slitting	AC-D	Metal
Diamond cutting disc	Cutting, slitting	DC-TP, DC-D (SPX, SP, P)	Mineral
Abrasive grinding disc	Rough grinding	AG-D, AF-D, AN-D	Metal
Diamond grinding disc	Rough grinding	DG-CW (SPX, SP, P)	Mineral
Diamond core bit	Drilling in tiles	DD-M14	Mineral

## Suitability of discs for the equipment used

Item	Equipment	AC-D	AG-D	AF-D	AN-D	DG-CW	DC-D	DD-M14
A	Guard	X	X	X	X	X	X	X
B	Front cover (in combination with A)	X	-	-	-	-	X	-
C	DG-EX 125/5" guard for surface grinding	-	-	-	-	X	-	-
D	DC-EX 125/5"-C compact guard (in combination with A)	-	-	-	-	-	X	-
E	Side handle	X	X	X	X	X	X	X
F	DC BG 125 hoop grip (optional for E)	X	X	X	X	X	X	X
G	Clamping nut	X	X	X	X	X	X	-
H	Clamping flange	X	X	X	X	X	X	-
I	<b>Kwik lock</b> (optional for G)	X	X	X	X	-	X	-

### 3.9 Li-ion battery charge status display

The charge status of the Li-ion battery is displayed after one of the two battery release buttons is pressed.

Status	Meaning
4 LEDs light.	• Charge status: 75 % to 100 %
3 LEDs light.	• Charge status: 50 % to 75 %
2 LEDs light.	• Charge status: 25 % to 50 %
1 LED lights up.	• Charge status: 10 % to 25 %
1 LED blinks.	• Charge status: < 10 %



#### Note

Indication of the charge status is not possible while the power tool is in operation or immediately after operation. If the battery charge status LEDs blink, please refer to the information given in the Troubleshooting section.

## 4 Technical data

### 4.1 Angle grinder

	AG 125-A36	AG 150-A36
<b>Rated voltage</b>	36 V	36 V
<b>Rated speed</b>	9,500 /min	8,500 /min
<b>Maximum disc diameter</b>	125 mm	150 mm
<b>Weight in accordance with EPTA procedure 01/2003</b>	3.5 kg	3.5 kg
<b>Drive spindle thread (arbor size)</b>	M14	M14
<b>Spindle length</b>	22 mm	22 mm

### 4.2 Noise information and vibration values determined in accordance with EN 60745

The sound pressure and vibration values given in these instructions have been measured in accordance with a standardized test and may be used to compare one electric tool with another. They may be used for a preliminary assessment of exposure.

The data given represents the main applications of the power tool. However, if the power tool is used for different applications, with different accessory tools or is poorly maintained, the data may vary. This may significantly increase exposure over the total working period.

An accurate estimation of exposure should also take into account the times when the power tool is switched off, or when it is running but not actually being used for a job. This may significantly reduce exposure over the total working period.

Identify additional safety measures to protect the operator from the effects of noise and/or vibration, for example: maintaining the power tool and accessory tools, keeping the hands warm, organization of work patterns.

**Noise emission values determined in accordance with EN 60745**

<b>Emission sound pressure level (<math>L_{pA}</math>)</b>	80 dB(A)
<b>Uncertainty for the sound pressure level (<math>K_{pA}</math>)</b>	3 dB(A)
<b>Sound (power) level (<math>L_{WA}</math>)</b>	91 dB(A)
<b>Uncertainty for the sound power level (<math>K_{WA}</math>)</b>	3 dB(A)

**Total vibration (vector sum of three directions), measured in accordance with EN 60745**

Other applications, such as cutting, may produce vibration values that deviate from the given values.

	<b>AG 125-A36</b>	<b>AG 150-A36</b>
<b>Surface grinding with the vibration-absorbing side handle (<math>a_{h,AG}</math>)</b>	3.2 m/s <sup>2</sup>	4.6 m/s <sup>2</sup>
<b>Uncertainty (K)</b>	1.5 m/s <sup>2</sup>	1.5 m/s <sup>2</sup>

**5 Before use**

**5.1 Inserting the battery**

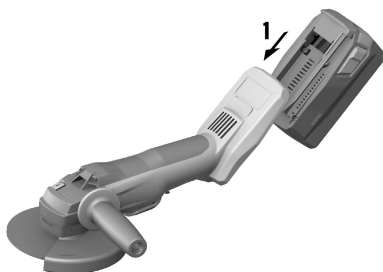

**CAUTION**  
**Risk of injury.** Due to the angle grinder starting unintentionally.

- ▶ Before fitting the battery, check that the angle grinder is switched off and that the safety lock is activated.

**CAUTION**  
**Electrical hazard.** Dirty contacts may cause a short circuit.

- ▶ Before inserting the battery, check to ensure that the battery terminals and the contacts in the angle grinder are free from foreign objects.

**CAUTION**  
**Risk of injury.** If the battery is not fitted correctly it may drop out and fall.

- ▶ Check that the battery is securely seated in the tool so that it cannot drop out and fall, thereby presenting a hazard to other persons.

- ▶ Fit the battery and check that the battery is securely seated in the power tool.

## 5.2 Removing the battery

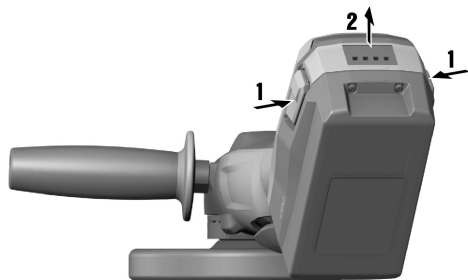

- ▶ Remove the battery.

## 5.3 Fitting the side handle

- ▶ Screw the side handle into one of the threaded bushings provided.

## 5.4 Fitting or removing the guard



### CAUTION

**Risk of injury.** The accessory tool may be hot or have sharp edges.

- ▶ Wear protective gloves when fitting, removing or adjusting the accessory tool or other parts and when troubleshooting.

- ▶ Observe the instructions for fitting the applicable guard.

### 5.4.1 Fitting the guard



### Note

The guard is equipped with locating lugs that ensure only guards of a type suitable for use with the power tool can be fitted. The locating lugs of the guard fit into the guard mount on the power tool.

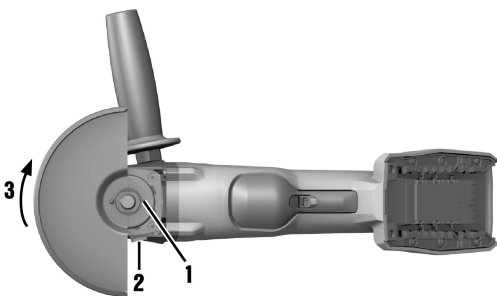

1. Fit the guard onto the drive spindle collar so that the two triangular marks on the guard and on the power tool are in alignment.
2. Press the guard onto the drive spindle collar.
3. Press the guard release button.
4. Rotate the guard until it engages and the guard release button jumps back into its original position.



### 5.4.2 Adjusting the guard

- ▶ Press the guard release button and then rotate the guard until it engages in the desired position.

### 5.4.3 Removing the hood

1. Press the guard release button and then rotate the guard until the triangular marks on the guard and the power tool are in alignment.
2. Remove the guard.

### 5.5 Fitting or removing the front cover



#### Note

The front cover, when used, is clipped onto the guard.

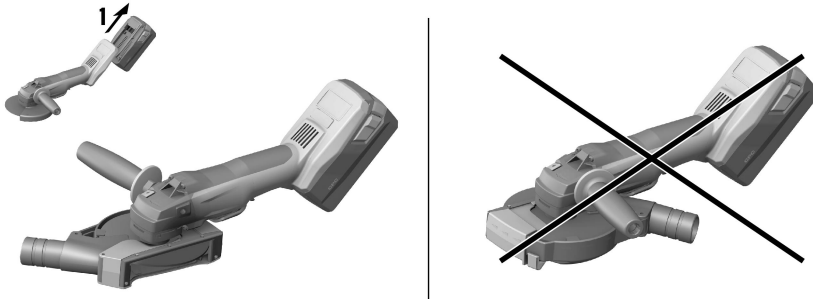

1. Position the front cover with the closed side on the standard guard and push it on until it engages.
2. To remove it, release the catch for the front cover and then lift the front cover away from the standard guard.

### 5.6 Positioning the DC-EX 125/5" C compact guard

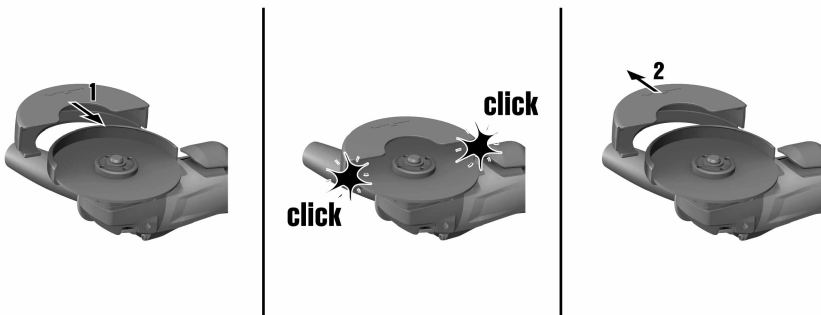

- ▶ Position the compact guard so that the on/off switch remains easily accessible and operable at all times.

### 5.7 Fitting and removing accessory tools



#### CAUTION

**Risk of injury.** The accessory tool may be hot.

- ▶ Wear protective gloves when changing the accessory tool.



## Note

Diamond discs must be replaced when their cutting or grinding performance drops significantly. This generally is the case when the segments reach a height of less than 2 mm.  
Other discs must be replaced when their cutting performance drops significantly or other parts of the angle grinder (not the disc) come into contact with the material you are working on.  
Abrasive discs must be replaced when their expiry date has been reached.

### 5.7.1 Fitting an accessory tool

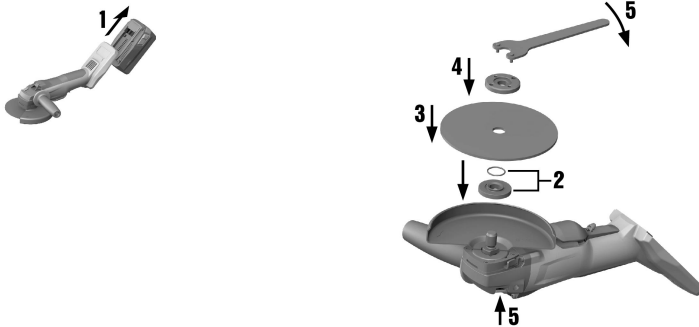

1. Remove the battery. → page 14
2. Check that the O-ring is in place in the clamping flange and that it is undamaged.

#### Result

The O-ring is damaged.

There is no O-ring in the clamping flange.

► Fit a new clamping flange with O-ring.

3. Fit the clamping flange onto the drive spindle (keyed fit to prevent slipping/rotation).
4. Fit the accessory tool.

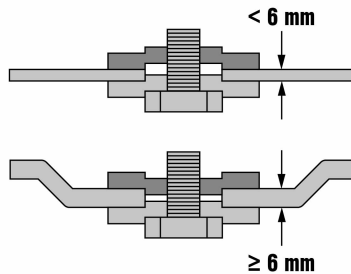

#### WARNING

**Risk of injury.** The accessory tool may work loose due to the braking effect of the motor.

- Wait until the accessory tool has come to a standstill before touching or gripping the accessory tool or the clamping nut.
- Secure the accessory tool by tightening the clamping flange and clamping nut firmly so that no parts work loose from the spindle due to the braking effect of the motor.

5. Screw on the clamping nut corresponding to the type of accessory tool fitted.
6. Press the spindle lockbutton and hold it in this position.

7. Use the pin wrench to tighten the clamping nut securely, then release the spindle lockbutton and remove the wrench.

### 5.7.2 Removing the accessory tool

1. Remove the battery. → page 14



#### CAUTION

**Risk of breakage and irreparable damage.** If the spindle lockbutton is pressed while the spindle is rotating, this may cause the accessory tool to work loose or detach from the power tool.

- ▶ Press the spindle lockbutton only when the spindle has stopped rotating.

2. Press the spindle lockbutton and hold it in this position.
3. Release the clamping nut by gripping it with the wrench and turning the nut counterclockwise.
4. Release the spindle lockbutton and remove the accessory tool.

### 5.7.3 Fitting an accessory tool secured with a Kwik lock nut



#### CAUTION

**Risk of breakage.** Heavy wear (abrasion) may cause the **Kwik lock** nut to break.

- ▶ When working with the power tool, make sure that the **Kwik lock** nut doesn't come into contact with the working surface.
- ▶ Do not use a damaged **Kwik lock** nut.



#### Note

The optional **Kwik lock** nut can be used instead of the standard clamping nut. Accessory tools (discs etc.) can then be changed without need for additional tools (keyless system).

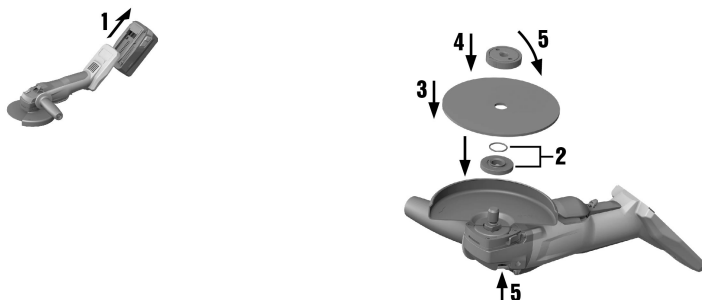

1. Remove the battery. → page 14
2. Clean the clamping flange and the quick-release clamping nut.
3. Fit the clamping flange onto the drive spindle.
4. Fit the accessory tool.
5. Screw on the **Kwik lock** nut until it is seated against the accessory tool.
  - ◀ The name **Kwik lock** should be visible when the nut is screwed on.
6. Press the spindle lockbutton and hold it in this position.
7. Turn the accessory tool firmly by hand in a clockwise direction until the **Kwik lock** nut is tightened securely and then release the spindle lockbutton.

### 5.7.4 Removing an accessory tool secured with a Kwik lock nut

1. Remove the battery. → page 14



### CAUTION

**Risk of breakage and irreparable damage.** If the spindle lockbutton is pressed while the spindle is rotating, this may cause the accessory tool to work loose or detach from the power tool.

- ▶ Press the spindle lockbutton only when the spindle has stopped rotating.

2. Press the spindle lockbutton and hold it in this position.
3. Release the **Kwik lock** nut by turning it counterclockwise by hand.
4. If the **Kwik lock** nut cannot be released by turning it by hand, use a pin wrench to turn the nut in a counterclockwise direction.



### Note

Never use a pipe wrench! A pipe wrench could damage the **Kwik lock** nut.

5. Release the spindle lockbutton and remove the accessory tool.

## 6 Operation

### 6.1 Grinding



### CAUTION

**Risk of injury.** The accessory tool may suddenly stick or stall.

- ▶ Use the power tool with the side handle (or optional hoop grip) fitted and always hold the power tool securely with both hands.

### 6.2 Cutting

- ▶ When cutting, apply moderate feed pressure and do not tilt the power tool or the cutting disc (when working, hold at approx. 90° to the surface being cut).



### Note

For best results when cutting profiles and square tube, start cutting at the smallest cross section.

### 6.3 Rough grinding



### CAUTION

**Risk of injury.** The abrasive cutting disc could shatter and flying fragments may cause injury.

- ▶ Never use abrasive cutting discs for grinding.
- ▶ Move the power tool to and fro while maintaining a 5° to 30° angle of attack and applying moderate pressure.
    - ◀ This will avoid overheating and discoloration of the workpiece and help ensure an even surface finish.

### 6.4 Switching on (tool equipped with switch-on safety interlock)



### Note

The on / off switch with safety lock (switch-on interlock) gives you full control of the switch function and avoids unintentional starting.

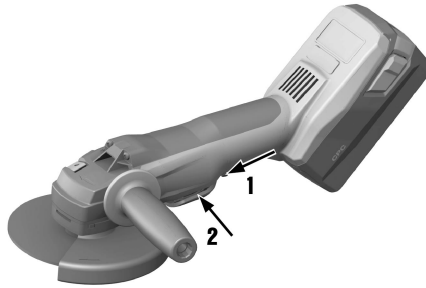

1. Push the safety lock forward.
  - ◀ The on/off switch is unlocked.
2. Press the on/off switch as far as it will go.
  - ◀ The power tool's motor runs at no-load speed.

### 6.5 Switching off (tool equipped with switch-on safety interlock)

- ▶ Release the on/off switch.
  - ◀ The safety lock jumps automatically into the locked position.

## 7 Care, maintenance, transport and storage

### 7.1 Care and maintenance of the power tool



#### **DANGER**

**Electric shock due to breakdown of protective insulation.** When working on metal under extreme conditions, conductive dust (e.g. metal, carbon fiber) may accumulate inside the power tool, thereby adversely affecting the protective insulation.

- ▶ Use a stationary dust extraction system when working under extreme conditions.
- ▶ Clean the air vents frequently.



#### **WARNING**

**Electrical hazards.** Improper repairs to electrical parts may lead to serious injuries.

- ▶ Electrical parts may be repaired only by trained electrical specialists.



#### **CAUTION**

**Unintentional starting.** If the battery is not removed from the power tool there is a risk of the power tool starting unintentionally while it is being cleaned. This could lead to injury.

- ▶ Remove the battery from the power tool before beginning cleaning.
- ▶ Keep the power tool, especially its grip surfaces, clean and free from oil and grease. Do not use cleaning agents containing silicone.
- ▶ Never operate the angle grinder when the air vents are blocked. Clean the air vents carefully using a dry brush. Do not permit foreign objects to enter the interior of the power tool.

- ▶ Clean the outer surfaces of the power tool with a slightly damp cloth at regular intervals. Do not use a spray system, pressure jet washer or running water for cleaning as this may negatively affect the electrical safety of the power tool.



**Note**

Frequent work on conductive materials (e.g. metal, carbon fiber) may make shorter maintenance intervals necessary. Take your individual workplace risk assessment into account.



**Note**

To help ensure safe and reliable operation, use only genuine Hilti spare parts and consumables. Spare parts, consumables and accessories approved by us for use with the product can be found at your local **Hilti** Center or online at: [www.hilti.com](http://www.hilti.com)

## 7.2 Care of the Li-ion battery

- ▶ Keep the battery clean and free from oil and grease.
- ▶ Clean the outer surfaces with a slightly damp cloth at regular intervals. Do not use cleaning agents containing silicone.
- ▶ To achieve maximum battery life, stop drawing power from the battery as soon as a significant drop in the performance of the power tool is noticed.
- ▶ Charge the batteries using the **Hilti** chargers approved for use with Li-ion batteries.

## 7.3 Checks after care and maintenance work

- ▶ After carrying out care and maintenance, check that all protective and safety devices are fitted and that they function faultlessly.

## 7.4 Transport and storage



**WARNING**

**Fire hazard.** Risk of short circuiting.

- ▶ Never store or transport Li-ion batteries in loose, bulk form.

- ▶ Pull the battery out of its locked position and into the first engagement position.
- ▶ Observe the nationally and internationally applicable transport regulations when shipping batteries by road, rail, sea or air.



**Note**

Ideally, the battery should be stored in a fully-charged state in a dry place that is as cool as possible. Storing the battery in places subject to high ambient temperatures (e.g. at a window) has an adverse effect on battery life and increases the rate of self-discharge.

If the battery no longer reaches full charge, it may have lost capacity due to aging or overstraining. It is still possible to work with this battery. You should, however, soon replace the battery with a new one.

## 8 Troubleshooting

If the trouble you are experiencing isn't listed in this table or you are unable to remedy the problem by yourself, please contact **Hilti** Service.

Trouble or fault	Possible cause	Action to be taken
The battery runs down more quickly than usual.	Very low ambient temperature.	▶ Allow the battery to warm up slowly to room temperature.
The battery doesn't engage with an audible click.	The retaining lugs on the battery are dirty.	▶ Clean the retaining lugs and refit the battery.
1 LED blinks. The power tool doesn't run.	Low battery.	▶ Change the battery and charge the empty battery.
	The battery is too hot or too cold.	▶ Allow the battery to cool down or warm up slowly to room temperature.

Trouble or fault	Possible cause	Action to be taken
All 4 LEDs blink. The power tool doesn't run.	The tool has been overloaded.	▶ Release the control switch and then press it again. Then allow the power tool to run under no load for approx. 30 seconds.
The angle grinder or battery gets very hot.	Electrical fault.	▶ Switch the power tool off immediately, remove the battery, keep it under observation, allow it to cool down and contact <b>Hilti Service</b> .
The tool does not achieve full power.	A battery with inadequate capacity was used.	Capacity: > 2.6 Ah ▶ Use a battery with adequate capacity.
The motor has no braking effect.	Low battery.	▶ Change the battery and charge the empty battery.
	The power tool was overloaded briefly.	▶ Release the control switch and then press it again.

## 9 Disposal



### WARNING

**Risk of injury.** Hazards presented by improper disposal.

- ▶ Improper disposal of the equipment may have the following consequences: The burning of plastic components generates toxic fumes which may present a health hazard. Batteries may explode if damaged or exposed to very high temperatures, causing poisoning, burns, acid burns or environmental pollution. Careless disposal may permit unauthorized and improper use of the equipment. This may result in serious personal injury, injury to third parties and pollution of the environment.
- ▶ Dispose of defective batteries right away. Keep them out of reach of children. Do not disassemble or incinerate the batteries.
- ▶ Batteries that have reached the end of their life must be disposed of in accordance with national regulations or returned to **Hilti**.

 Most of the materials from which **Hilti** tools and appliances are manufactured can be recycled. The materials must be correctly separated before they can be recycled. In many countries, your old tools, machines or appliances can be returned to **Hilti** for recycling. Ask **Hilti Service** or your Hilti representative for further information.

In accordance with the European Directive on waste electrical and electronic equipment and its implementation in conformance with national law, electric tools or appliances that have reached the end of their life must be collected separately and returned to an environmentally compatible recycling facility.



- ▶ Disposal of electric tools or appliances together with household waste is not permissible.

## 10 Manufacturer's warranty

- ▶ Please contact your local **Hilti** representative if you have questions about the warranty conditions.

## 11 EC declaration of conformity

### Manufacturer

Hilti Aktiengesellschaft  
Feldkircherstrasse 100  
9494 Schaan

**Liechtenstein**

We declare, on our sole responsibility, that this product complies with the following directives and standards.

Designation	Angle grinder
Type designation	AG 125-A36
Generation	02
Year of design	2014
Type designation	AG 150-A36
Generation	02
Year of design	2014
Applied directives:	<ul style="list-style-type: none"> <li>• 2006/42/EC</li> <li>• 2014/30/EU</li> <li>• 2006/66/EC</li> <li>• 2011/65/EU</li> </ul>
Applied standards:	<ul style="list-style-type: none"> <li>• EN 60745-1, EN 60745-2-3</li> <li>• EN ISO 12100</li> </ul>
Technical documentation filed at:	<ul style="list-style-type: none"> <li>• Electric Tools Approval Department Hilti Entwicklungsgesellschaft mbH Hiltistraße 6 86916 Kaufering <b>Germany</b></li> </ul>

Schaan, 6/2015



Paolo Luccini  
(Head of BA Quality & Process Management /  
Business Area Electric Tools & Accessories)



Tassilo Deinzer  
(Executive Vice President / Business Unit Power  
Tools & Accessories)







Hilti Corporation

LI-9494 Schaan

Tel.: +423/234 21 11

Fax: +423/234 29 65

[www.hilti.com](http://www.hilti.com)

Hilti = registered trademark of Hilti Corp., Schaan



20161209