

HILTI

VC 300-17 X

English



1 Information about the documentation

1.1 About this documentation

- Read this documentation before initial operation or use. This is a prerequisite for safe, trouble-free handling and use of the product.
- Observe the safety instructions and warnings in this documentation and on the product.
- Always keep the operating instructions with the product and make sure that the operating instructions are with the product when it is given to other persons.

1.2 Explanation of signs used

1.2.1 Warnings

Warnings alert persons to hazards that occur when handling or using the product. The following signal words are used in combination with a symbol:



DANGER! Draws attention to imminent danger that will lead to serious personal injury or fatality.



WARNING! Draws attention to a potential hazard that could lead to serious personal injury or fatality.



CAUTION! Draws attention to a potentially dangerous situation that could lead to minor personal injury or damage to the equipment or other property.

1.2.2 Symbols in the documentation

The following symbols are used in this document:



Read the operating instructions before use



Instructions for use and other useful information

1.2.3 Symbols in the illustrations

The following symbols are used in illustrations:



These numbers refer to the corresponding illustrations found at the beginning of these operating instructions.

3

The numbering reflects the sequence of operations shown in the illustrations and may deviate from the steps described in the text.



Item reference numbers are used in the **overview illustrations** and refer to the numbers used in the **product overview section**.



These characters are intended to specifically draw your attention to certain points when handling the product.

1.3 Product-dependent symbols

1.3.1 Symbols on the product

The following symbols are used on the product:



Warning: hot surface



Transport by crane is not permissible.

1.4 Product information

Hilti products are designed for professional use and may be operated, serviced and maintained only by trained, authorized personnel. This personnel must be informed of any particular hazards that may be encountered. The product and its ancillary equipment can present hazards if used incorrectly by untrained personnel or if used not in accordance with the intended use.

The type designation and serial number are stated on the rating plate.

- ▶ Write down the serial number in the table below. You will be required to state the product details when contacting Hilti Service or your local Hilti organization to inquire about the product.

Product information

Wet / dry vacuum cleaner	VC 300-17 X
Generation	01
Serial no.	

1.5 Declaration of conformity

We declare, on our sole responsibility, that the product described here complies with the applicable directives and standards. A copy of the declaration of conformity can be found at the end of this documentation.

The technical documentation is filed and stored here:

Hilti Entwicklungsgesellschaft mbH | Tool Certification | Hiltistrasse 6 | 86916 Kaufering, Germany

2 Safety

2.1 General safety instructions

In addition to the safety instructions given in the various sections of these operating instructions, the following points must be strictly observed at all times.

- ▶ **Read all the instructions.** Failure to follow all the instructions listed below may result in electric shock, fire and/or serious injury.
- ▶ **If the appliance is used in conjunction with an electric tool, read and follow the operating instructions for the electric tool and all the warnings.**
- ▶ **Modification of the appliance is not permitted.**
- ▶ **Use the right appliance for the job. Do not use the appliance for purposes for which it was not intended. Use it only as directed and when in faultless condition.**
- ▶ **Before beginning work with the appliance, find out how to operate it correctly and about any hazards associated with the materials it will be picking up and how these materials can be disposed of.**
- ▶ **Take the influences of the surrounding area into account. Do not use the appliance where there is a risk of fire or explosion.**
- ▶ **The appliance may only be used by persons who are familiar with it, have been trained on how to use it safely and who understand the resulting hazards. The appliance is not intended for use by children. Children must be supervised in order to ensure that they don't play with the appliance.**
- ▶ **Store appliances in a secure place when not in use. When not in use, appliances must be stored in a dry, high place or locked away out of reach of children.**

2.2 Personal safety

- ▶ **Stay alert, watch what you are doing and use common sense when working with the product. Do not use the vacuum cleaner while you are tired or under the influence of drugs, alcohol or medication.** A moment of inattention while operating the appliance may result in serious personal injury.
- ▶ **The user and any other persons in the vicinity must wear suitable eye protection, a hard hat, ear protection, protective gloves, safety footwear and breathing protection while the appliance is in use or while maintenance work on it is being carried out.**
- ▶ **Engage the wheel brakes so that the vacuum cleaner stands securely.** If the wheel brakes are disengaged the vacuum cleaner may run away out of control.
- ▶ **If devices are provided for the connection of dust extraction and collection facilities, ensure these are connected and properly used.** Use of a vacuum cleaner can reduce dust-related hazards.

2.3 Use and care of the appliance

- ▶ **Never leave the appliance unattended.**
- ▶ **Do not deactivate the filter cleaning system when picking up hazardous dusts, especially when the appliance is used in conjunction with electric tools that generate dust.**
- ▶ **Protect the appliance from frost.**
- ▶ **Clean the water level limiting device regularly with a brush, in accordance with the instructions, and check it for signs of damage.**
- ▶ **When fitting the top section of the vacuum cleaner, take care to avoid pinching your fingers or damaging the supply cord.** This presents a risk of injury or damage.

- ▶ **Check the appliance and its accessories for any damage. Guards, safety devices and any slightly damaged parts must be checked carefully to ensure that they function faultlessly and as intended. Check that moving parts function faultlessly, without sticking, and that no parts are damaged. In order to ensure faultless operation of the appliance, all parts must be fitted correctly and must meet the necessary requirements.**
- ▶ **Have the appliance serviced by a qualified repair person using only genuine Hilti spare parts.** The safety of the appliance can thus be maintained.
- ▶ **Always unplug the supply cord from the power outlet when the appliance is not in use (during breaks), before cleaning and maintenance and before changing the filter or accessories.** This preventive safety measure reduces the risk of starting the appliance accidentally.
- ▶ **Never pull the vacuum cleaner by the supply cord to a new working position. Do not run the wheels of the vacuum cleaner over the supply cord.**
- ▶ **Do not transport the appliance by crane.**

2.4 Electrical safety

- ▶ **The plug on the supply cord of the appliance must match the outlet. Do not change the plug in any way. Do not use adapter plugs with earthed (grounded) appliances.** Unmodified plugs and matching outlets reduce risk of electric shock.
- ▶ **Insert the plug in a suitable earthed/grounded power outlet which has been correctly and safely installed and is in compliance with local regulations. If you are in doubt about the effectiveness of the power outlet's earth/ground connection, have it checked by a qualified specialist.**
- ▶ **Avoid body contact with earthed or grounded surfaces such as pipes, radiators, cookers, stoves and refrigerators.** There is an increased risk of electric shock if your body is grounded.
- ▶ **Do not expose the appliance to rain or wet conditions.** Water entering an electric appliance will increase the risk of electric shock.
- ▶ **Check to ensure that the supply cord does not lie in a puddle of water.**
- ▶ **Check the appliance's supply cord at regular intervals and have it replaced by Hilti Service if damage is found. Check extension cords at regular intervals and replace them if found to be damaged.**
- ▶ **Do not touch the supply cord or extension cord if they are damaged while working. Disconnect the supply cord plug from the power outlet.** Damaged supply cords or extension cords present a risk of electric shock.
- ▶ The electric supply cord may be replaced only with a cord of the type specified in the operating instructions.
- ▶ **Do not abuse the cord. Never use the cord for carrying, pulling or unplugging the appliance. Keep the cord away from heat, oil, sharp edges or moving parts.** Damaged or entangled cords increase the risk of electric shock.
- ▶ **When operating an electric appliance outdoors, use only extension cords of a type suitable for outdoor use.** Use of an extension cord suitable for outdoor use reduces the risk of electric shock.
- ▶ **In the event of an interruption in the electric supply, switch the appliance off and unplug it from the power outlet.**
- ▶ **Use the power outlet on the appliance only for the purposes described in the operating instructions.**
- ▶ **Never operate the appliance when it is dirty or wet.** Dust (especially dust from conductive materials) or dampness adhering to the surface of the appliance may, under unfavorable conditions, lead to electric shock. **Dirty or dusty appliances should thus be checked by Hilti Service at regular intervals, especially if used frequently for working on conductive materials.**

2.5 Workplace

- ▶ **Ensure that the workplace is well lit.**
- ▶ **Ensure that the workplace is well ventilated.** Exposure to dust at a poorly ventilated workplace may result in damage to the health.
- ▶ **Keep the workplace tidy. Objects which could cause injury should be removed from the working area.** Untidiness at the workplace can lead to accidents.
- ▶ **Do not operate the appliance in explosive atmospheres, such as in the presence of flammable liquids, gases or dust.** Electric appliances cause sparks which may ignite the dust or fumes.
- ▶ **Use extra care when working on stairs.**

2.6 The material picked up

- ▶ Do not use the appliance to pick up flammable or explosive dusts (magnesium or aluminum dust etc.) or dusts that present a health hazard. Do not use the appliance to pick up materials hotter than 60°C (140°F), (e.g. glowing cigarette ends, hot ash).
- ▶ Do not use the appliance to pick up flammable, explosive or aggressive liquids (coolants and lubricants, gasoline, solvents, acids (pH < 5), alkalies (pH > 12.5), etc.).
- ▶ Switch the appliance off immediately if foam or liquids escape from it.
- ▶ Wear protective gloves when using the appliance to pick up hot materials at temperatures of up to 60°C (140°F).
- ▶ When working with mineral drilling slurry, wear protective clothing and avoid skin contact with the slurry (pH > 9: caustic).
- ▶ Avoid contact with alkaline or acidic liquids. If contact accidentally occurs, rinse with water. In the event of the liquid coming into contact with the eyes, rinse the eyes with plenty of water and consult a doctor.

3 Description

3.1 Product overview

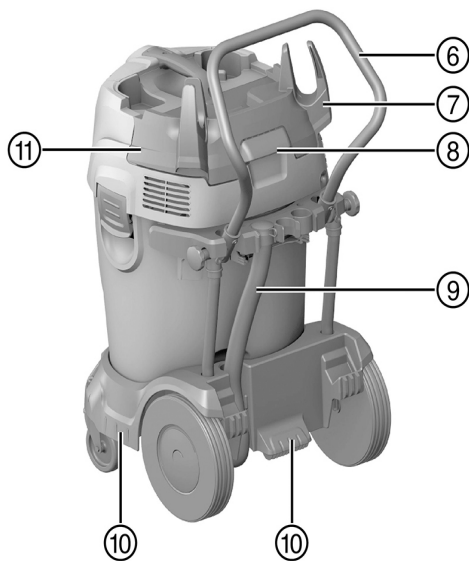
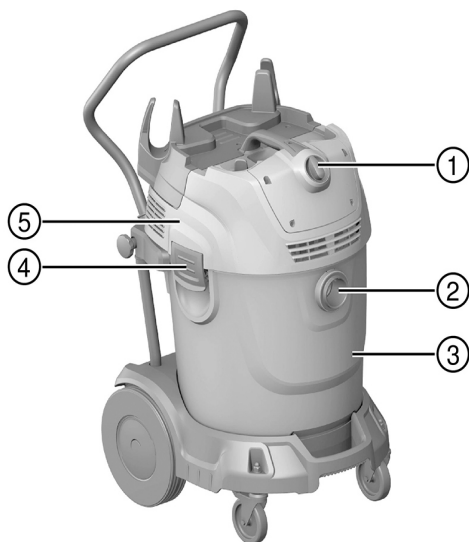

- | | |
|----------------------------|--------------------------|
| ① Control switch | ⑦ Supply cord hook |
| ② Intake fitting | ⑧ Catch for filter cover |
| ③ Waste material container | ⑨ Drain hose (optional) |
| ④ Catch | ⑩ Grip recesses |
| ⑤ Suction head | ⑪ Filter cover |
| ⑥ Container handle | |

3.2 Intended use

The product described here is a general-purpose industrial vacuum cleaner for commercial use. It can be used to pick up wet or dry materials.

Use of the product to clean down persons or animals is not permissible. Underwater use is not permissible.



WARNING

Health hazard! U-type vacuum cleaners are not suitable for picking up hazardous dust.

- ▶ Do not use these vacuum cleaner models to pick up hazardous dust.

- ▶ Before beginning work with the product, find out how to operate it correctly and about any hazards associated with the materials you will be working with and how these materials can be disposed of safely.
- ▶ Do not use the product for continuous, stationary operation in automatic or semi-automatic systems.
- ▶ To reduce the risk of injury, use only genuine **Hilti** accessories and accessory tools.
- ▶ Use an antistatic suction hose in order to avoid electrostatic effects.
- ▶ Do not pick up objects or materials that could cause injury by piercing through the dust bag (e.g. pointed or sharp objects).
- ▶ Do not stand on the product (do not use it as a substitute for a ladder).

This product is suitable for the following applications in commercial use:

- Collecting large quantities of dust from **Hilti** diamond grinders, diamond cutters, rotary hammers and core drilling machines using dry-cutting core bits.
- Picking up drilling slurry (mineral materials) with **Hilti** diamond core bits or **Hilti** diamond saws and liquids up to a temperature of < 60 °C (140 °F).
- Picking up oil or liquid substances with a temperature of up to < 60 °C (140 °F).
- Wet and/or dry cleaning of wall and floor surfaces.



3.3 Possible misuse

- Do not operate the industrial vacuum cleaner when it is laid on its side.
- Do not use the industrial vacuum cleaner to pick up substances that present a risk of explosion, glowing, burning or flammable substances or aggressive dusts (e.g. magnesium or aluminum dust, etc.) (exception: wood chips or shavings).
- Do not use the industrial vacuum cleaner to pick up flammable liquids (e.g. gasoline, solvents, coolants and lubricants, etc.).
- Working with materials hazardous to health (e.g. asbestos) is not permissible.

3.4 Items supplied

Wet/dry vacuum cleaner including filter element, suction hose complete with hose connector, plastic dust bag, operating instructions.

3.5 Control switch

Symbol	Meaning
	Switching on
	Switching off
	Switching on, with filter cleaning

3.6 Automatic filter cleaning

The appliance is equipped with a filter cleaning system for fine dust. The filter is cleaned automatically every 7.5 seconds by a blast of air.

The filter element is cleaned automatically by a blast of air (a pulsating noise is heard).



Note

In order to achieve continuously high suction performance in system applications (especially grinding and sanding, cutting and slitting) or when picking up large quantities of dust, the filter cleaning system must be active.

The filter cleaning system functions only when a suction hose is connected.

4 Technical data

4.1 Wet / dry vacuum cleaner



Note

If the appliance is powered by a generator or transformer, the generator or transformer's power output must be at least twice the rated input power shown on the rating plate of the appliance. The operating voltage of the transformer or generator must always be within +5 % and -15 % of the rated voltage of the appliance.

	VC 300-17 X
Dimensions (L x W x H in mm)	575 x 490 x 880
Weight in accordance with EPTA procedure 01	27.5 kg
Maximum volumetric flow rate (air)	2 x 74 ℓ/s
Container capacity	65 ℓ
Water capacity	48 ℓ
Suction hose connector (C-DN/C-ID)	40 mm
Ambient temperature (max.)	40 °C
Automatic filter cleaning, all	7.5 s
Protection class	I
Protection class	IPX4
Power rating	2,400 W
Mains (AC) voltage	220 V ...240 V
AC frequency	50 Hz ...60 Hz

4.2 Noise and vibration information (measured in accordance with EN 60335-2-69)

The following information applies to the VC 300-17 X industrial vacuum cleaner.

Sound pressure level L_{pA}	73 dB(A)
Uncertainty K_{pA}	1 dB(A)
Vibration emission value	< 2.5 m/s ²
Uncertainty (K)	0.2 m/s ²

5 Before use



DANGER

Electrical hazards. Fatal or serious injury may result if the vacuum cleaner is not correctly connected to the electric supply.

- ▶ Connect the vacuum cleaner only to a properly earthed/grounded power source.



CAUTION

Risk of injury presented by the appliance running away out of control. The vacuum cleaner may run away out of control if the wheel brakes are not engaged.

- ▶ Engage the wheel brakes so that the vacuum cleaner stands securely.

5.1 Operating the appliance for the first time



Note

Plastic dust bag: For collecting harmless dust types:
Plastic dust bag for mineral dust or paper dust bag for wood chips:

1. Open the two catches.
2. Lift the vacuum cleaner top section away from the waste material container.
3. Remove the accessories and packaging from the waste material container.
4. Fit a suitable dust bag in accordance with the instructions.



Note

When used to pick up harmless dusts: plastic dust bag.

5. Fit the vacuum cleaner top section onto the waste material container and close the two catches.
6. Check to ensure that the vacuum cleaner top section is fitted correctly and secured.
7. Connect the suction hose to the appliance.

5.2 Fitting/changing the fabric dust bag



DANGER

Risk of injury. Sharp pointed objects may pierce through the dust bag.

- ▶ Check that no objects have pierced through the dust bag.

1. Pull the plug out of the power outlet.
2. Open the two catches.
3. Lift the vacuum cleaner top section away from the waste material container.
4. Close the cap at the mouth of the dust bag.
5. Clean the waste material container with a cloth.
6. Secure the new fabric dust bag in the waste material container.
7. Fit the vacuum cleaner top section onto the waste material container and close the two catches.

5.3 Fitting/changing the plastic dust bag

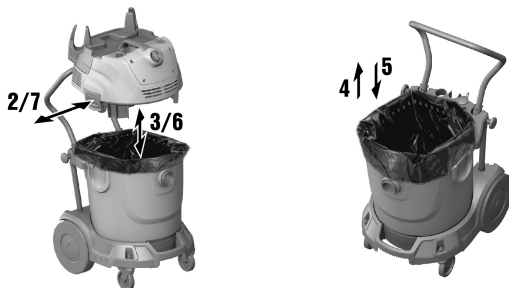
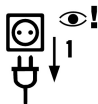

1. Disconnect the supply cord plug from the power outlet.
2. Open the two catches.
3. Lift the vacuum cleaner top section away from the waste material container.
4. Use a cable tie to close the plastic dust bag below the punched holes.
5. Remove the plastic dust bag.
6. Clean the waste material container with a cloth.
7. Fit a new plastic dust bag (see instructions printed on it) in the waste material container.
8. Fit the vacuum cleaner top section onto the waste material container and close the two catches.

6 Operation



WARNING

Risk of injury. Damage to the filter system may allow harmful dust (health hazard) to escape.

- ▶ In an emergency (e.g. filter ruptured), switch the vacuum cleaner off, unplug the supply cord from the power outlet and have the vacuum cleaner checked by a trained and qualified person before further use.



CAUTION

Risk of injury presented by the appliance running away out of control. The vacuum cleaner may run away out of control if the wheel brakes are not engaged.

- ▶ Engage the wheel brakes so that the vacuum cleaner stands securely.

6.1 Picking up dry dust



Note

Before picking up dry dust, especially dust from mineral materials, always check to ensure that the correct dust bag is fitted in the container. The material picked up by the vacuum cleaner can then be disposed of cleanly and easily.



CAUTION

Risk of injury. Hazardous material that has been picked up may escape if a filter element is not used.

- ▶ Never use the appliance without a filter element.
- ▶ Check that the filter element is dry and that the correct type of dust bag is fitted.

6.2 Picking up liquids



CAUTION

Risk of injury. Hazardous material that has been picked up may escape if a filter element is not used.

- ▶ Never use the appliance without a filter element.

1. Check the container level monitoring system. → page 12
2. If possible, use a separate filter element for wet applications.
3. After picking up liquids, open the two catches.
4. Lift the vacuum cleaner top section away from the waste material container and place it on a level surface so that the filter element can dry.
5. Empty the waste material container and use a water hose to rinse it out. Use a brush to clean the electrodes and clean the filter element, after allowing it to dry, by wiping it off with your hand.
6. Allow the waste material container to dry.

6.3 After use of the vacuum cleaner

1. Switch off the electric tool.
2. To switch the appliance off, turn the control switch to the **0** position.
3. Unplug the vacuum cleaner's supply cord from the power outlet.
4. Coil up the supply cord and hang it on the hook.
5. Empty the container and clean the appliance by wiping it with a damp cloth.
6. Coil up the suction hose.
7. Store the vacuum cleaner in a secure, dry place where it is inaccessible to unauthorized users.

6.4 Emptying dry dust from the waste material container

1. Disconnect the supply cord plug from the power outlet.
2. Lift the vacuum cleaner top section away from the waste material container and place it on a level surface.
3. Remove the dust bag from the waste material container or grip the container by the recess provided and empty it by tipping out the contents.
4. Fit the vacuum cleaner top section onto the waste material container and close the two catches.

6.5 Emptying the waste material container when no dust bag is fitted (picking up liquids)

1. Disconnect the supply cord plug from the power outlet.
2. Lift the vacuum cleaner top section away from the waste material container and place it on a level surface.
3. Grip the waste material container by the recess provided and empty it by tipping out the contents.
4. Clean the edge of the waste material container with a cloth.
5. Fit the vacuum cleaner top section onto the waste material container and close the two catches.

6.6 Draining off waste water



Note

Observe local regulations regarding the treatment of waste water.

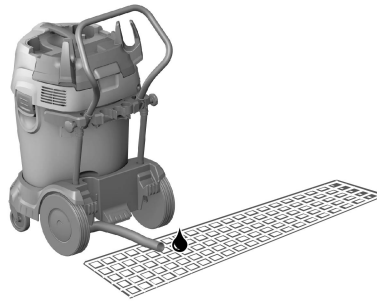

1. Remove the cap from the draining hose.
2. Take the draining hose out of the holder.
3. Lay the draining hose on the ground or floor.
 - ◀ The waste water drains away.

7 Care and maintenance

7.1 Care and maintenance of the appliance



WARNING

Electrical hazards. Improper repairs to electrical parts may lead to serious injuries.

- ▶ Electrical parts may be repaired only by trained electrical specialists.

- ▶ Keep the appliance, especially its grip surfaces, clean and free from oil and grease. Do not use cleaning agents containing silicone.
- ▶ Never operate the vacuum cleaner when the air vents are blocked. Clean the air vents carefully using a dry brush. Do not permit foreign objects to enter the interior of the appliance.
- ▶ Clean the outer surfaces of the appliance with a slightly damp cloth at regular intervals. Do not use a spray system, pressure jet washer or running water for cleaning as this may negatively affect the electrical safety of the appliance.

7.2 Automatic filter cleaning



Note

Do not attempt to clean the filter element by knocking it against a hard object and do not use pointed instruments. This will reduce the life of the filter element.

Do not use compressed air to clean the filter element. This may cause tears in the filter material.

The condition of the filter element deteriorates with use.

- ▶ Replace the filter element at least every six months.
- ▶ However, if used intensively, the filter element should be replaced more often.

7.3 Fitting/changing the filter element

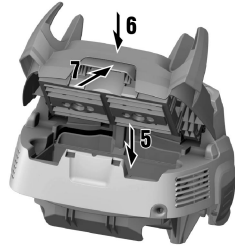
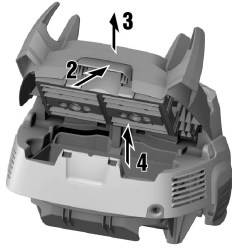
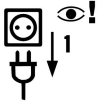

1. Disconnect the supply cord plug from the power outlet.
2. Open the filter cover catches.
3. Open the filter cover.
4. Carefully remove the filter element, gripping it at the areas provided in the holder.
5. Clean the sealing surface with a cloth.
6. Fit the new filter element.
7. Close the filter cover by flipping the cover catch forward.
8. Close the filter cover catch.

7.4 Checking the container level monitoring system

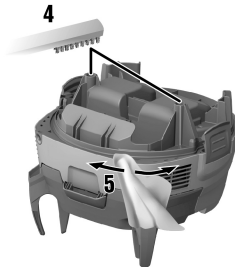
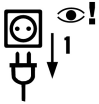

1. Engage the wheel brakes so that the vacuum cleaner stands securely.
2. Disconnect the supply cord plug from the power outlet.
3. Open the two catches.
4. Lift the vacuum cleaner top section away from the waste material container and place it on a level surface.
5. Check the cut-out contacts and clean them with a brush if necessary (if dirty).
6. Check the seal at the vacuum cleaner top section and clean it with a cloth if necessary.
7. Fit the vacuum cleaner top section onto the waste material container and close the two catches.

7.5 Checks after cleaning and maintenance

1. After cleaning or carrying out maintenance, check that the vacuum cleaner is assembled correctly and that it functions faultlessly.
2. Test each of the functions.

8 Transport and storage

8.1 Transport

Do not carry the appliance when it is full of waste material.

The appliance may not be lifted directly by crane.

- ▶ Remove the power conditioner (if applicable) or loose accessory tools from the holder.
- ▶ Empty the appliance before carrying it to another location.
- ▶ Do not tip the appliance or transport it lying on its side after using it to pick up liquids.
- ▶ Use the tapered adapter to connect both ends of the hose together conveniently for transport.

8.2 Storage

- ▶ Store the vacuum cleaner in a secure, dry place where it is inaccessible to unauthorized users.

9 Troubleshooting

If the trouble you are experiencing is not listed in this table or you are unable to remedy the problem by yourself, please contact **Hilti** Service.

9.1 Troubleshooting table

Trouble or fault	Possible cause	Action to be taken
The vacuum turbine doesn't start.	No electric power.	▶ Check the power outlet and fuse.
	The sensors are clogged with dirt.	▶ Check the container level monitoring system. → page 12
The vacuum turbine switches itself off.	The container is full.	▶ Empty the container.
The vacuum turbine doesn't start after cleaning the waste material container.	The automatic cut-out is active.	▶ Set the control switch to the 0 position. ▶ Wait 5 seconds. ▶ Set the control switch to the 1 position.
	The sensors are clogged with dirt.	▶ Check the container level monitoring system. → page 12
Suction power drops.	The suction nozzle, tube, hose or the filter are blocked.	▶ Remove the blockage.
	The filter is clogged.	▶ Change the fabric dust bag. → page 8
	Remove the filter cover.	▶ Close the filter cover.
	The drainage hose leaks.	▶ Check the drainage hose for leakage.
Dust is blown out of the appliance.	The filter is fitted incorrectly.	▶ Change the fabric dust bag. → page 8
The automatic filter cleaning system doesn't work.	The suction hose is not connected.	▶ Connect the suction hose.
The appliance switches itself off or on inadvertently or static electricity discharges through the user.	Electrostatic charge is not conducted away – the appliance is connected to an unearthed/ungrounded power outlet.	▶ Connect the appliance to an earthed/grounded power outlet and use an antistatic suction hose.
The appliance doesn't start or switches itself off after a short time.	The water level cut-out is activated.	▶ Clean the sensors and the area around the sensors with a brush.
The motor doesn't restart.	The mains circuit breaker has been tripped.	▶ Reset the circuit breaker. ▶ Find the reason for the overload current if the circuit breaker trips again.

Trouble or fault	Possible cause	Action to be taken
The motor doesn't restart.	The waste material container is full.	▶ Switch the appliance off and empty the waste material container.
	The motor overheating protection cut-out has been activated.	▶ Switch the appliance off and allow it to cool down for about 5 minutes. ▶ If the motor doesn't start, return the appliance to Hilti Service.
	The motor is repeatedly switched off by its thermal cut-out.	▶ Clean the air vents carefully using a dry brush.
The motor doesn't run when set to "AUTO".	The appliance is faulty or is not correctly plugged in.	▶ Make sure that the supply cord plug is fully plugged in and check that the appliance functions correctly.

10 Disposal

 Most of the materials from which **Hilti** products are manufactured can be recycled. The materials must be correctly separated before they can be recycled. In many countries, your old tools, machines or appliances can be returned to **Hilti** for recycling. Ask **Hilti** Service or your Hilti representative for further information.

In accordance with the European Directive on waste electrical and electronic equipment and its implementation in conformance with national law, electric tools or appliances that have reached the end of their life must be collected separately and returned to an environmentally compatible recycling facility.



- ▶ Do not dispose of electric appliances together with household waste.

Drilling slurry

Disposal of drilling slurry directly into rivers, lakes or the sewerage system without suitable pretreatment presents environmental problems.

- ▶ Ask the local public authorities for information about current regulations.

We recommend the following pretreatment:

- ▶ Collect the drilling slurry (for example, using a wet-type vacuum cleaner).
- ▶ Allow the drilling slurry to settle and dispose of the solid material at a construction waste disposal site (addition of a flocculent may accelerate the settling process).
- ▶ The remaining water (alkaline, pH value greater than 7) must be neutralized by the addition of an acidic neutralizing agent or diluted with a large volume of water before it is allowed to flow into the sewerage system.

Drilling dust

- ▶ Dispose of the drilling dust collected by the vacuum cleaner in accordance with the applicable national regulations.

11 Manufacturer's warranty

- ▶ Please contact your local **Hilti** representative if you have questions about the warranty conditions.



Hilti Aktiengesellschaft
Feldkircherstraße 100
9494 Schaan | Liechtenstein

VC 300-17X (01)

[2017]

2006/42/EG

EN ISO 12100

2011/65/EU

EN 60335- 1

2014/30/EU

EN 60335-2-69

Schaan, 08/2017

A handwritten signature in black ink, appearing to read "Paolo Luccini".

Paolo Luccini

Head of BA Quality and
Process-Management
BA Electric Tools & Accessories

A handwritten signature in black ink, appearing to read "Johannes Winfried Huber".

Johannes Winfried Huber

Senior Vice President
Business Unit Diamond



Hilti Corporation

LI-9494 Schaan

Tel.: +423/234 21 11

Fax: +423/234 29 65

www.hilti.group

Hilti = registered trademark of Hilti Corp., Schaan



20170828